

Outsunny Instrucțiuni de asamblare

860-025

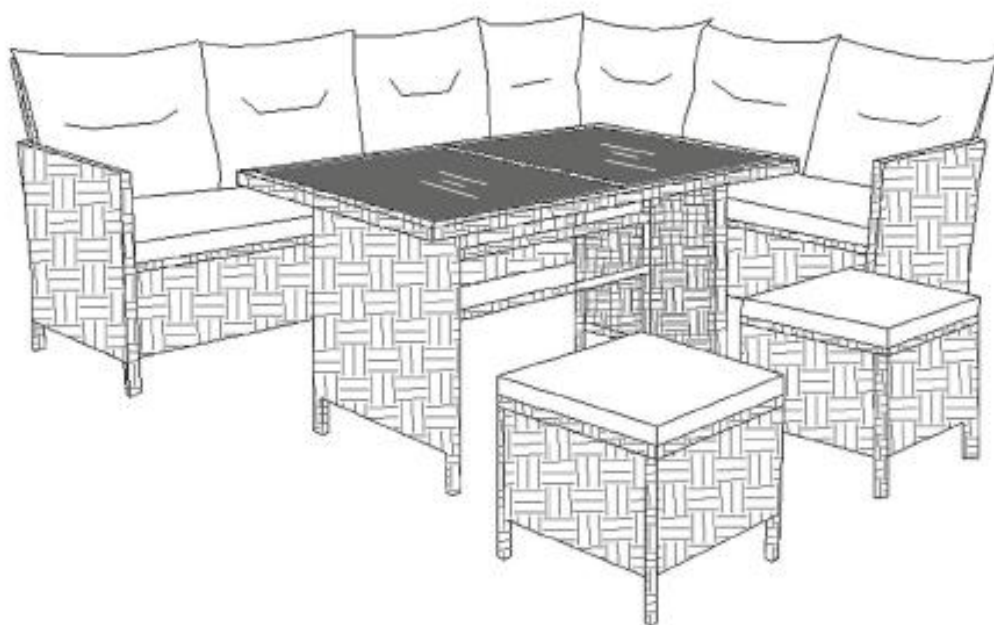

Masă

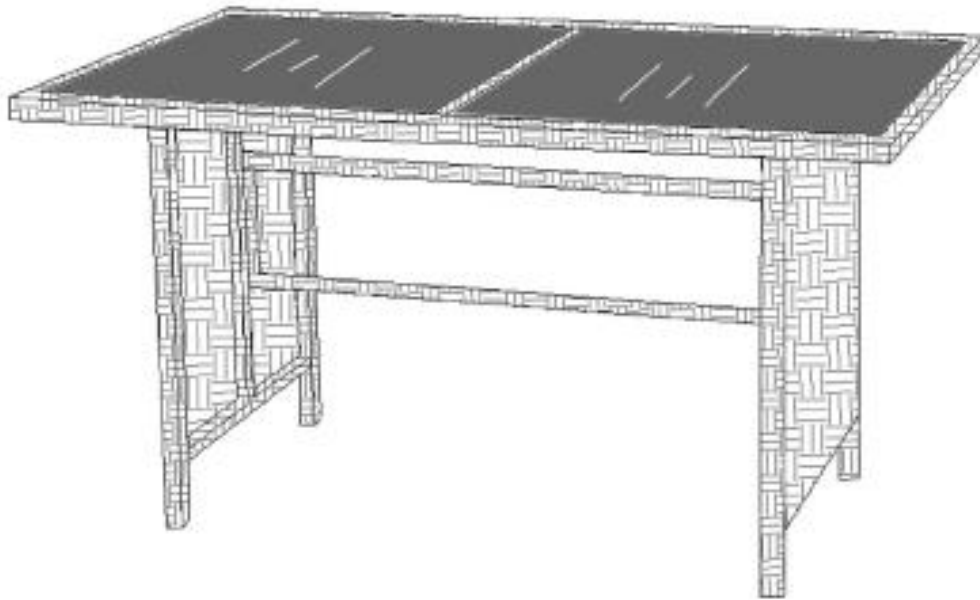

Listă de piese

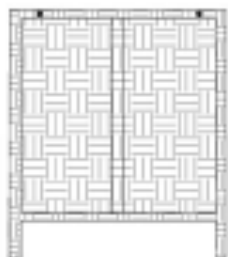

A 2 BUC.



B 1 BUC.

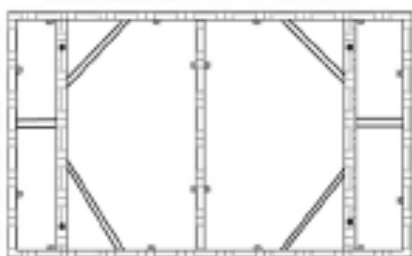

C 1 BUC.



D 2 BUC.



**b Ø6* 35
4 BUC.**



**d Ø6* 40
4 BUC.**



**c Ø6
8 BUC.**



**e
16 BUC.**

Etape de asamblare

PASUL 1

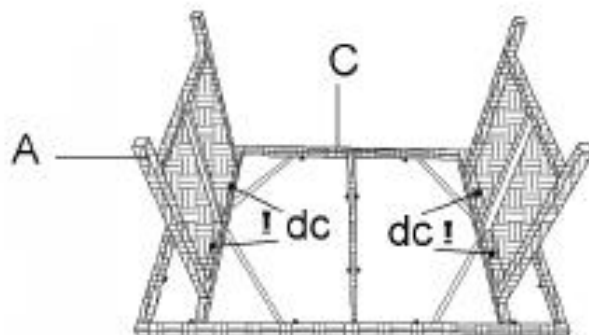

PASUL 2

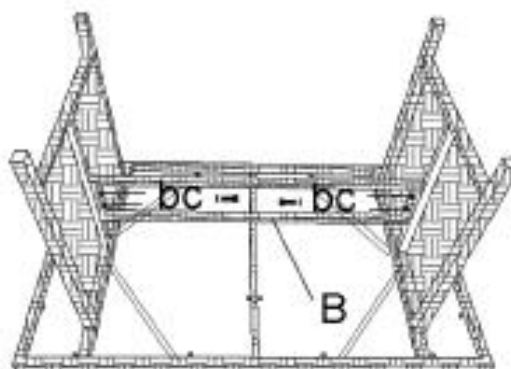

PASUL 3

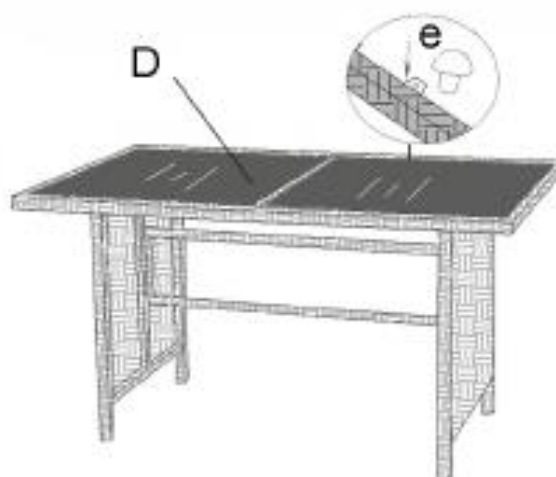

Atenție:

Strângeți șuruburile la ultimul pas de asamblare.

Pentru asamblarea acestui mobilier, este necesară prezența a două persoane.

Canapea colțar

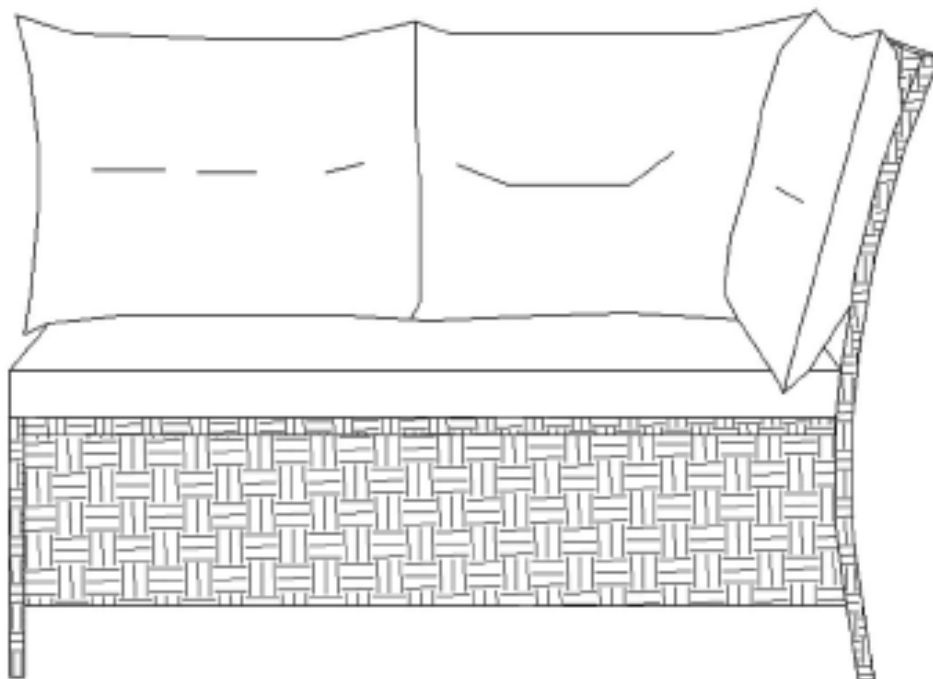

Listă de piese

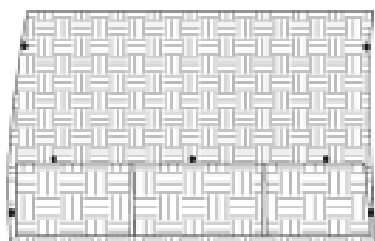

E 1 BUC.

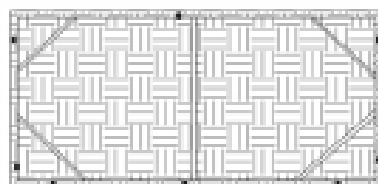

F 1 BUC.

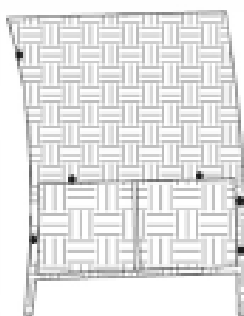

G 1 BUC.

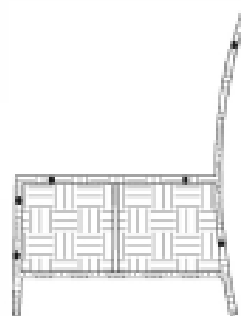

H 1 BUC.



I 1 BUC.



J 1 BUC.



K 2 BUC.



L 1 BUC.



**b Ø6*35
16 BUC.**



**c Ø6
16 BUC.**

Etape de asamblare

PASUL 1

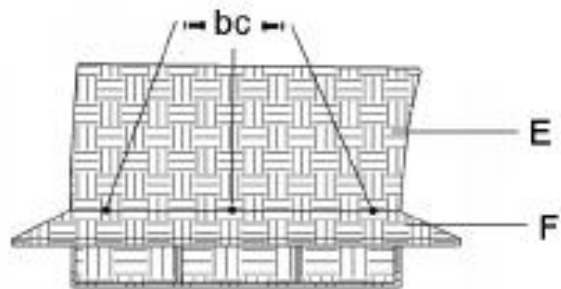

PASUL 2

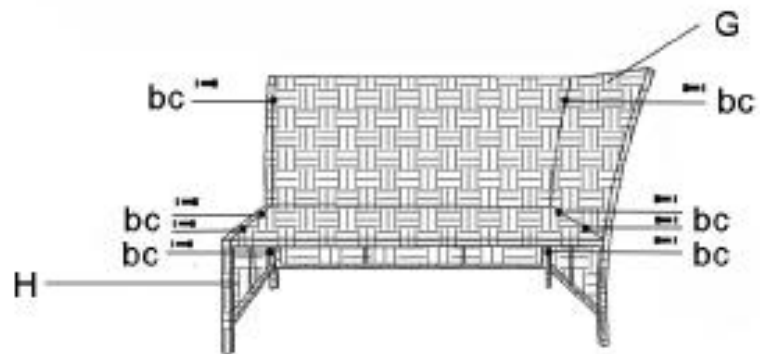

PASUL 3

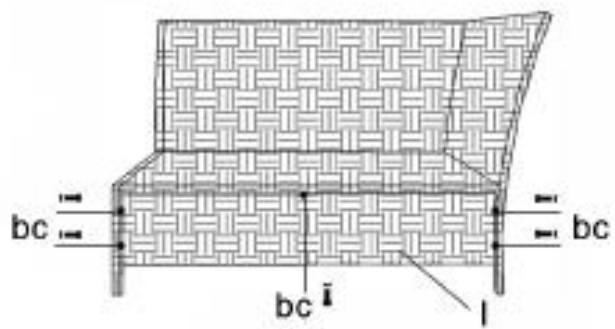

PASUL 4

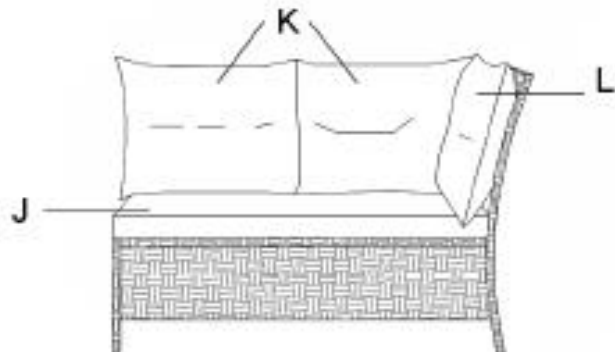

Canapea colțar Love stânga

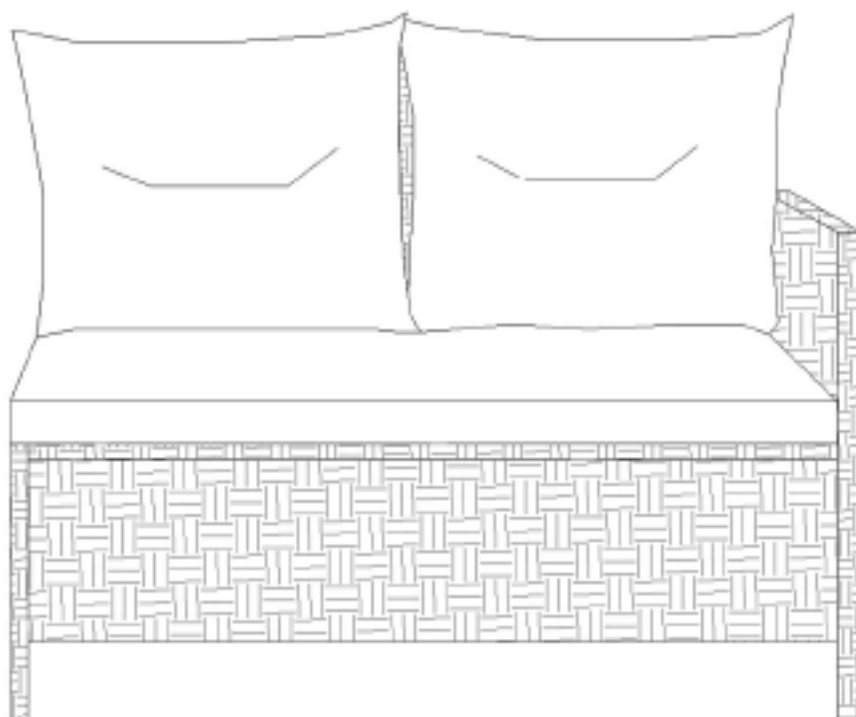

Listă de piese

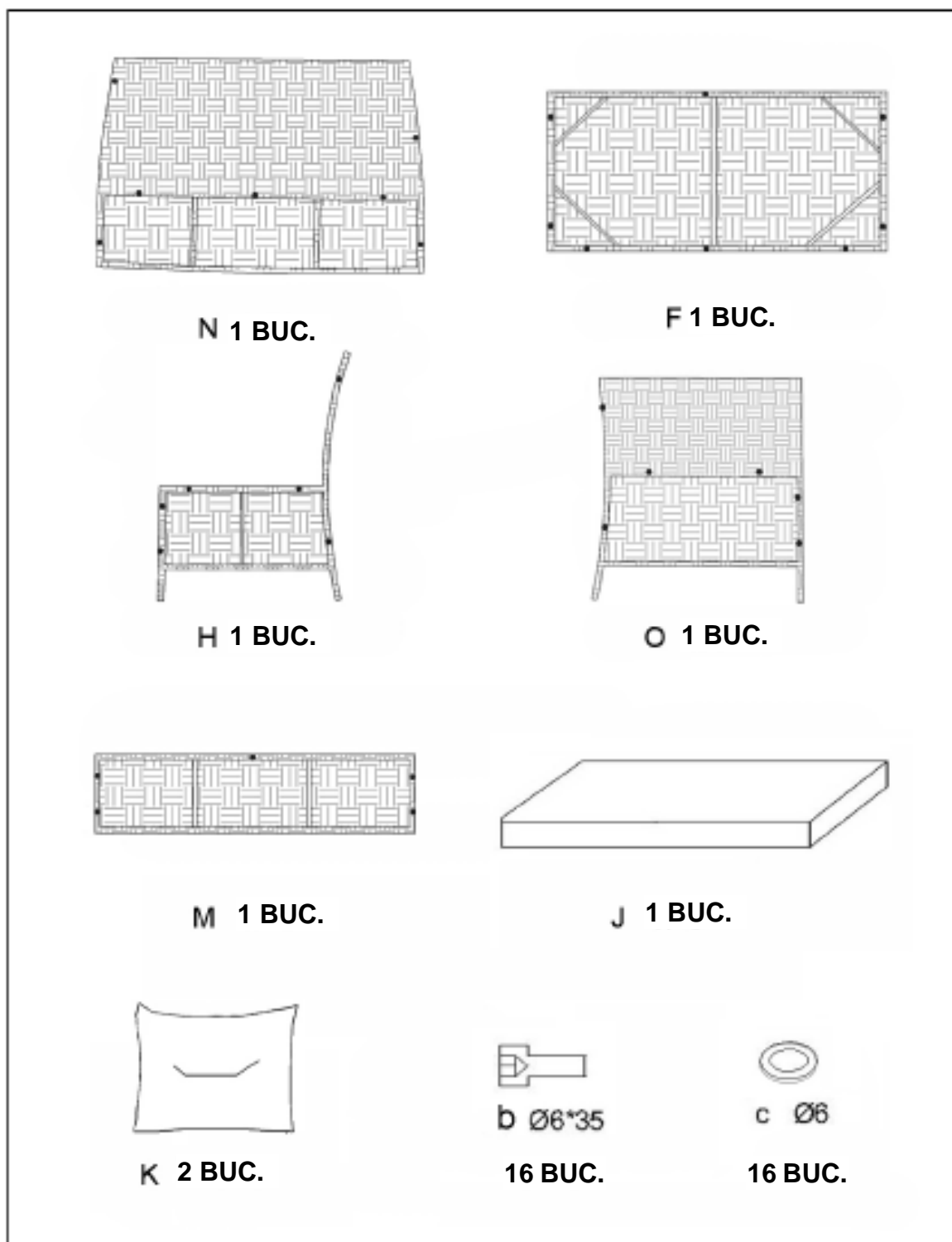

Etape de asamblare

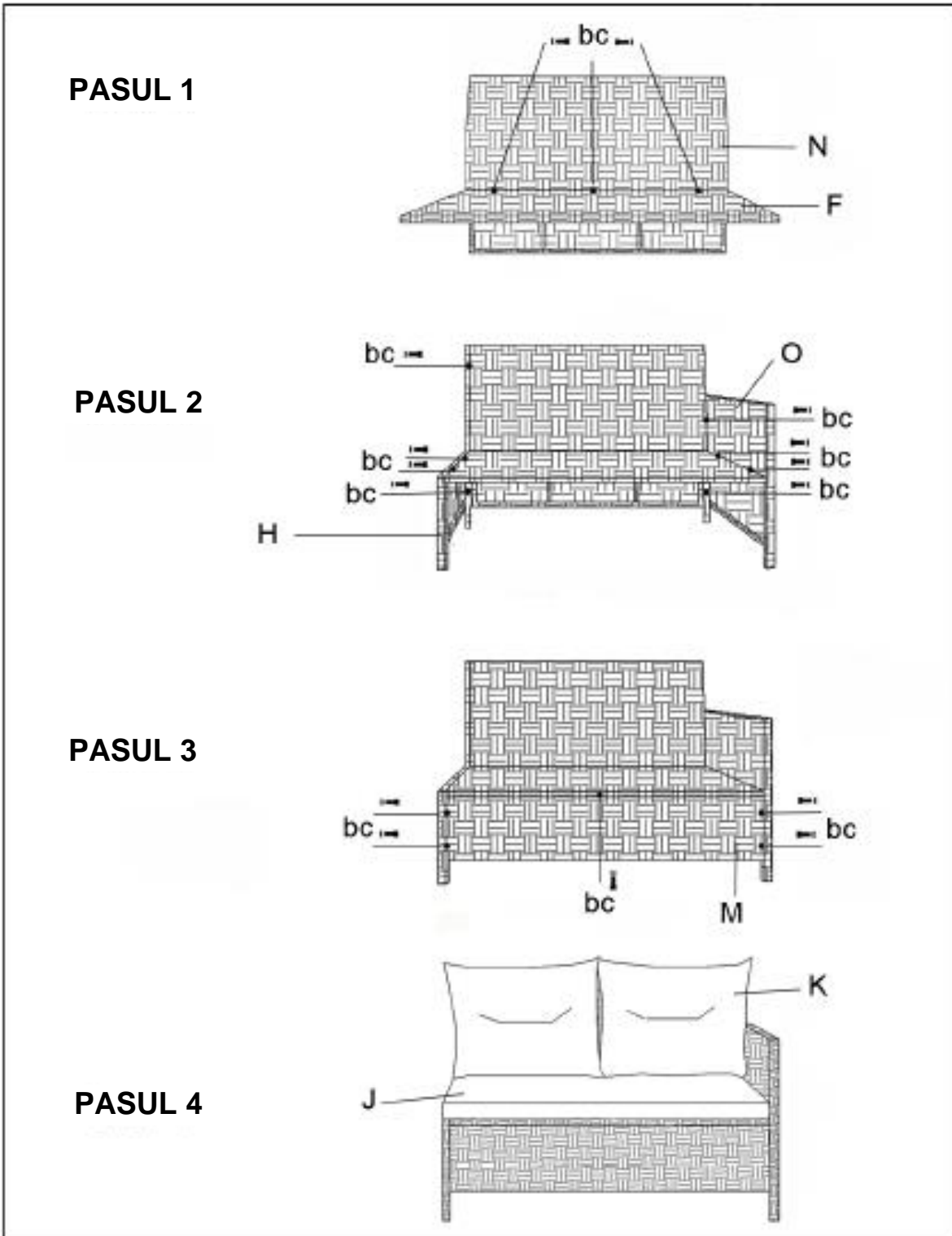

Canapea colțar Love dreapta

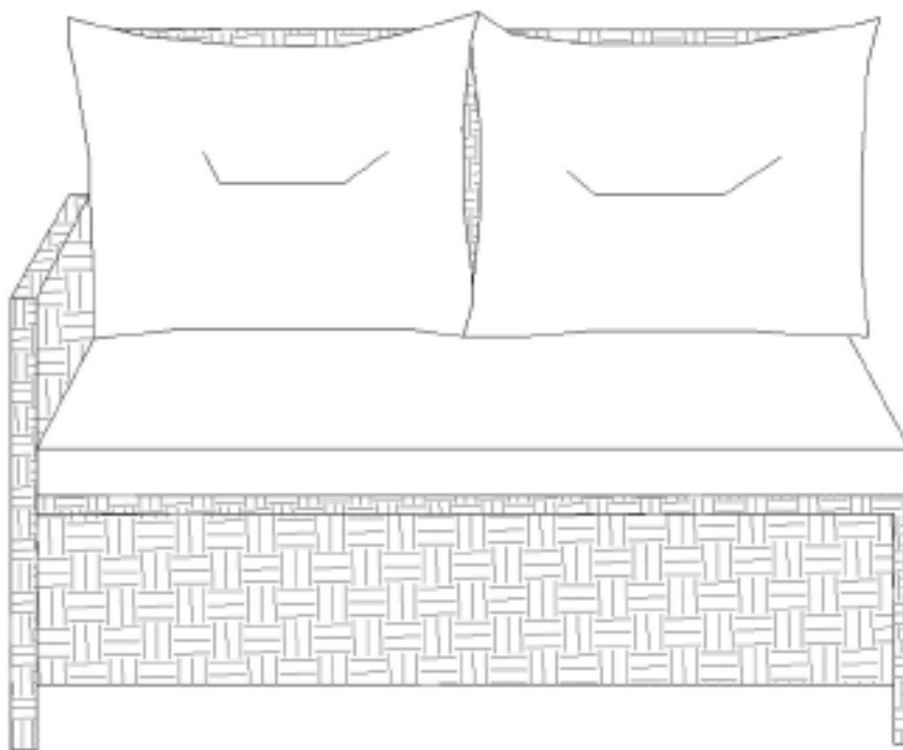

Listă de piese

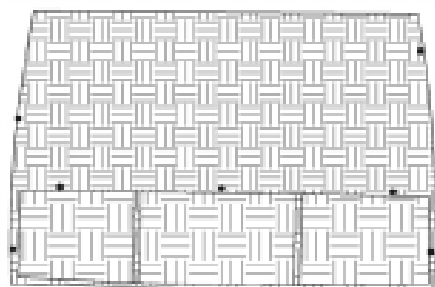

P 1 BUC.

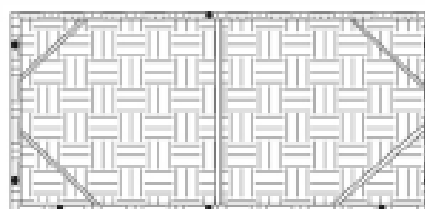

F 1 BUC.

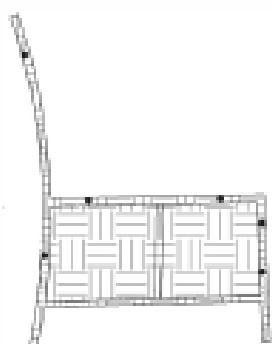

Q 1 BUC.

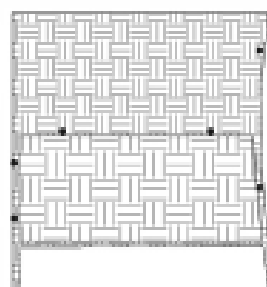

R 1 BUC.

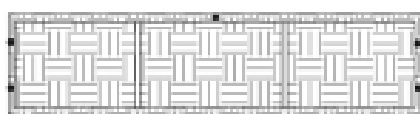

M 1 BUC.



J 1 BUC.



K 2 BUC.



**a Ø6*35
16 BUC.**



**c Ø6
16 BUC.**

Etape de asamblare

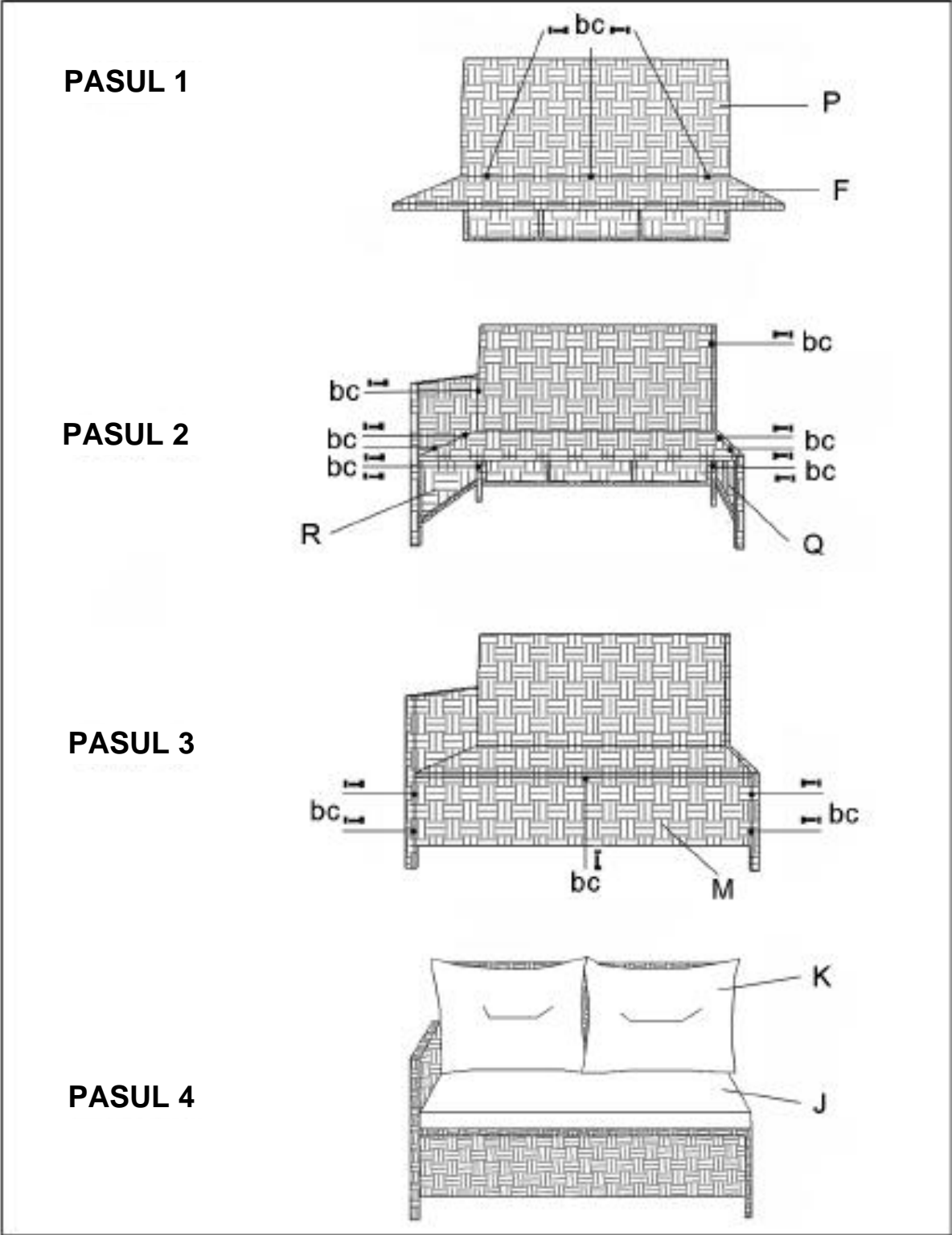

Taburet otoman

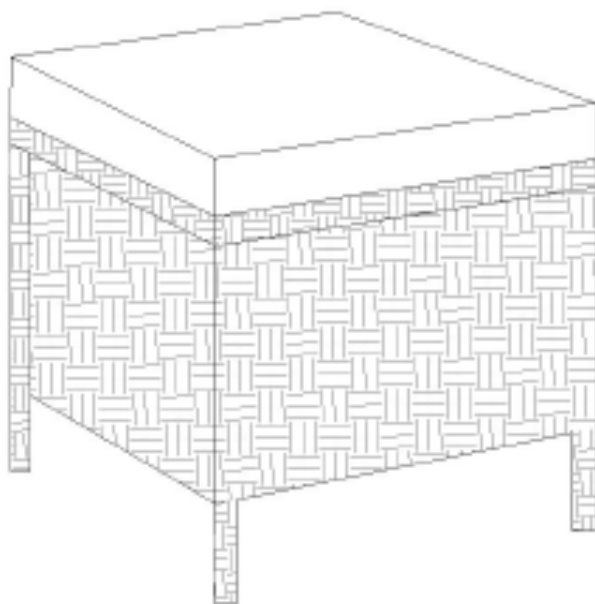

Listă de piese

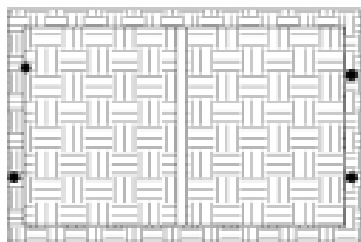

S 2 BUC.

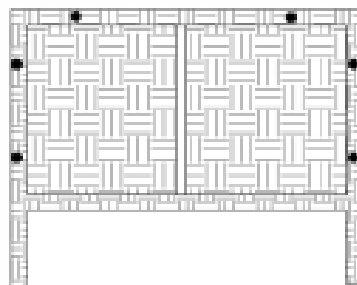

T 2 BUC.

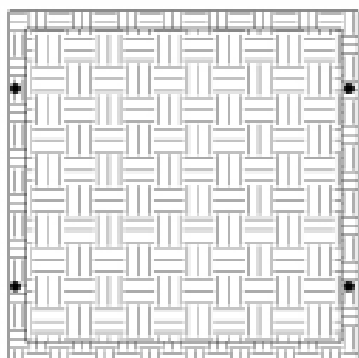

U 1 BUC.

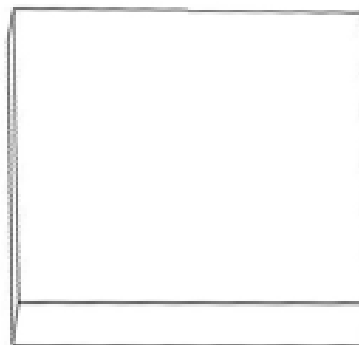

V 1 BUC.

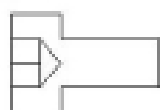

a Ø6*30
12 BUC.



c Ø6
12 BUC.

Etape de asamblare

PASUL 1

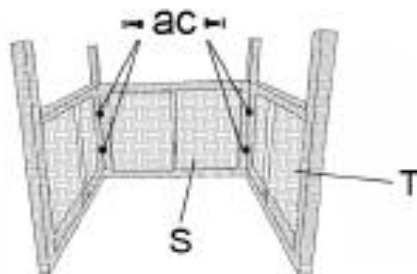

PASUL 2

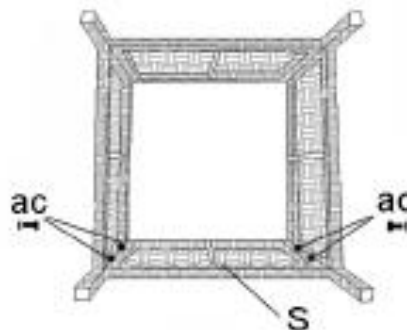

PASUL 3

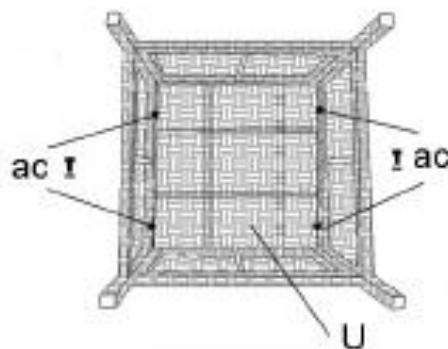

PASUL 4

