

N625P283231W / N625P283232W

Product manual

Gebrauchsanweisung

Manuel du produit

Manual del producto

Manuale del prodotto

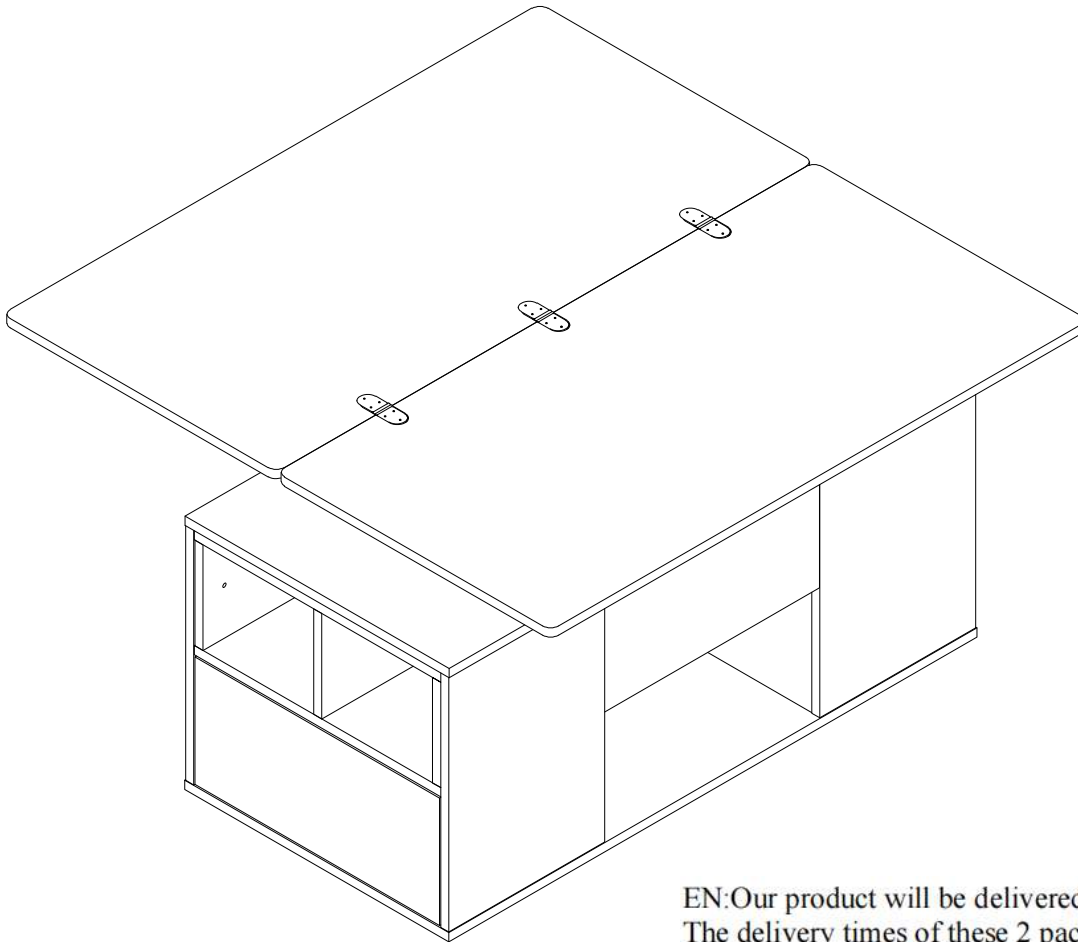

EN:Our product will be delivered to you in 2 packages.
The delivery times of these 2 packages may differ, please
be patient and thank you for your understanding

FR:Notre produit vous sera livré en 2 colis. Les délais de
livraison de ces 2 colis peuvent différer, soyez
patient et merci de votre compréhension.

DE:Unser Produkt wird Ihnen in 2 Paketen geliefert. Die
Lieferzeiten dieser 2 Pakete können abweichen, bitte haben
Sie etwas Geduld und vielen Dank für Ihr Verständnis

IT:I nostri prodotti vengono trasportati in due pacchetti. I
tempi di consegna dei due pacchetti sono diversi:
abbiate pazienza e vi ringrazio per la vostra comprensione

ES:Nuestro producto se entrega en dos paquetes. El
tiempo de entrega de estos dos paquetes es diferente. Por
favor, sea paciente. Gracias por su comprensión.

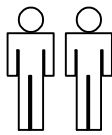
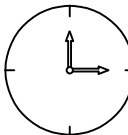
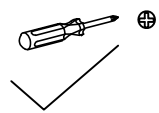
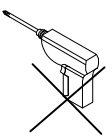
		Tool Required	Not Provided
 2PERS	 60MIN		



[DE]

Warnung: Lesen Sie die Anleitung vor dem Zusammenbau bitte vollständig durch. Überprüfen Sie, ob Sie alle auf den Seiten aufgeführten Komponenten und Werkzeuge haben.

Warnung: Legen Sie alle Teile auf eine ebene Fläche. Legen Sie eine weiche Decke oder Ähnliches darunter, um sie vor Kratzern oder Flecken zu schützen. Vermeiden Sie es, Komponenten über den Boden zu ziehen oder zu schieben.

Warnung: Überprüfen Sie regelmäßig alle Beschläge und Befestigungen, um sicherzustellen, dass sie sicher sind und um Unfälle zu vermeiden. Wenn Teile fehlen, kaputt, beschädigt oder abgenutzt sind, verwenden Sie das Produkt nicht weiter, bis es mit vom Hersteller autorisierten Teilen repariert wurde.

Warnung: Lassen Sie Kinder nicht auf die Möbel klettern, da dies zum Umkippen und zu schweren Verletzungen führen kann. Bauen Sie die Möbel außerhalb der Reichweite von Kindern zusammen.

Warnung: Stellen Sie die Möbel nicht in die Nähe von Feuerquellen oder heißen Gegenständen, um Brandgefahr zu vermeiden.

Warnung: Reinigen Sie die Möbel mit einem feuchten Tuch oder Alkohol. Verwenden Sie keine Reinigungsmittel mit ätzenden Chemikalien.

[EN]

Warning: Please read instructions fully before starting assembly. Check you have all the components and tools listed on pages.

Warning: Please place all parts on a flat surface. Place a soft blanket or similar underneath to protect against scratches or stains. Avoid dragging or sliding components across the floor.

Warning: Regularly check all fittings and fastenings to ensure they are secure and to prevent accidents. If any parts are missing, broken, damaged, or worn, discontinue use of the product until repairs have been made using factory authorized parts.

Warning: Do not allow children to climb on the furniture as this may result in tipping and serious personal injury. Assemble the furniture away from the reach of children.

Warning: Do not place furniture close to fire sources or high-temperature objects to avoid the risk of fire

Warning: Clean furniture with a damp cloth or alcohol, avoid using cleaning agents containing corrosive chemicals.

[FR]

Avertissement : Veuillez lire entièrement les instructions avant de commencer l'assemblage. Vérifiez que vous disposez de tous les composants et outils répertoriés sur les pages.

Avertissement : Veuillez placer toutes les pièces sur une surface plane. Placez une couverture douce ou similaire en dessous pour les protéger des rayures ou des taches. Évitez de faire glisser les composants sur le sol.

Avertissement : Vérifiez régulièrement tous les raccords et fixations pour vous assurer qu'ils sont bien fixés et pour éviter les accidents. Si des pièces manquent, sont cassées, endommagées ou usées, cessez d'utiliser le produit jusqu'à ce que des réparations aient été effectuées à l'aide de pièces autorisées par l'usine.

Avertissement : Ne laissez pas les enfants grimper sur les meubles car cela pourrait entraîner un basculement et des blessures graves. Assemblez les meubles hors de portée des enfants.

Avertissement : Ne placez pas les meubles à proximité de sources de feu ou d'objets à haute température pour éviter tout risque d'incendie.

Avertissement : Nettoyez les meubles avec un chiffon humide ou de l'alcool, évitez d'utiliser des produits de nettoyage contenant des produits chimiques corrosifs.

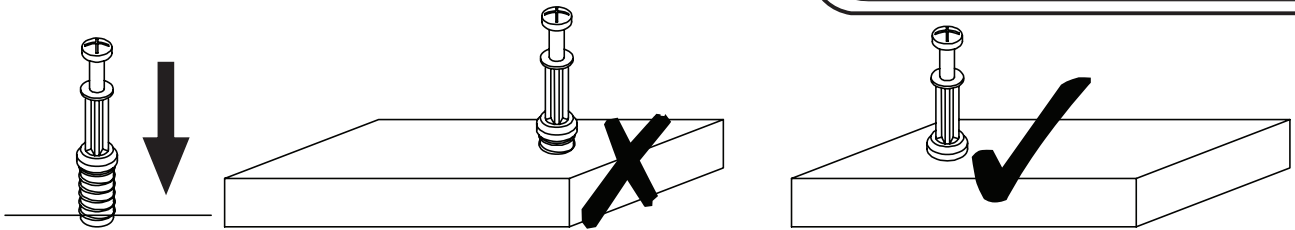

EN_QUICKFIT: Tighten quickfit until shoulder is flush with panel. Do not overtighten or undertighten.

FR_RACCORD RAPIDE: Faites serrer le raccord rapide jusqu'à ce que l'épaulement soit parfaitement encastré dans le panneau. Il ne faut ni trop serrer ni insuffisamment serrer.

ES_QUICKFIT: Apriete quickfit hasta que el hombro se descargue con el panel. NO lo sobreapriete ni lo apriete poco.

DE_QUICKFIT: Ziehen Sie den Quickfit fest, bis die Schulter mit der Platte bündig ist. Bitte nicht zu fest oder zu schwach anziehen.

IT_MONTAGGIO RAPIDO: Stringere il montaggio rapido fino a quando la spalla è a filo con il pannello, non stringere troppo o troppo poco.

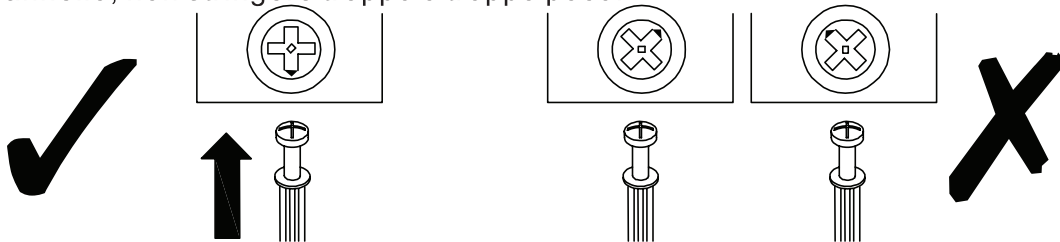

EN_CAM LOCK: When fitting cam lock, ensure starting position is correct before you insert connecting quickfit.

FR_SERRURE BATTEUSE: Avant d'insérer la serrure batteuse, veillez à la bonne orientation avant d'insérer le raccord rapide.

ES_CIERRE DE LA CÁMARA: Cuando instale el cierre de la cámara, asegúrese de que la posición de inicio es correcta antes de que inserte el quickfit conector.

DE_CAM-LOCK: Achten Sie bei der Montage des Cam-Locks auf die richtige Ausgangsposition, bevor Sie den Quickfit einsetzen.

IT_BLOCCAGGIO A CAMMA: Quando si monta il bloccaggio a camma, assicurarsi che la posizione iniziale sia corretta prima di inserire il montaggio rapido di collegamento.

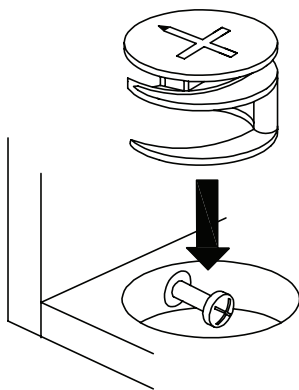

EN_Quickfit head should be in the centre of the cam lock when the two panels are joined.

Cam lock should be inserted before quickfit.

FR_Lorsque les deux panneaux sont assemblés, la tête du raccord rapide doit reposer au centre de la serrure batteuse. Il faut insérer la serrure batteuse avant le raccord rapide.

ES_El cabezal del quickfit debe estar en el centro del cierre de la cámara cuando se unan los dos paneles.

Se debe insertar el cierre de la cámara antes que el quickfit.

DE_Der Quickfit-Kopf sollte sich in der Mitte des Cam-Locks befinden, wenn die beiden Platten zusammengefügt sind. Der Cam-Lock sollte vor dem Quickfit eingesetzt werden.

IT_La testa del montaggio rapido deve trovarsi al centro del bloccaggio a camma quando i due pannelli sono uniti.

Il Bloccaggio a Camma deve essere inserito prima del montaggio rapido.

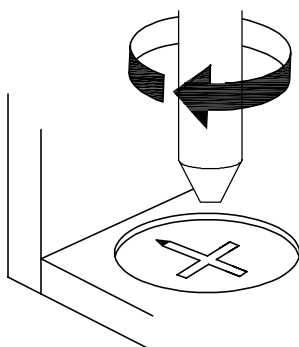

EN_Turn cam lock clockwise to tighten.

FR_Faites tourner la serrure batteuse dans le sens des aiguilles d'une montre pour la resserrer.

ES_Gire el cierre de la cámara en sentido horario para apretarlo.

DE_Drehen Sie den Cam-Lock im Uhrzeigersinn, um ihn festzuziehen.

IT_Ruotare il bloccaggio a camma in senso orario per stringere.

EN_NOTE: Pull inner and outer drawer runners apart before fixing them to panels.

FR_REMARQUE: Avant de fixer les glissières de tiroir aux panneaux, tirez vers l'extérieur et poussez vers l'intérieur de chacun des tiroirs.

ES_NOTA: retire los rieles interiores y exteriores antes de fijarlos a los paneles.

PT_NOTA: Separar as corrediças das gavetas interiores e exteriores antes de fixar para os painéis.

DE_HINWEIS: Ziehen Sie die inneren und äußeren Schubladenführung auseinander, bevor Sie sie an den Platten befestigen.

IT_NOTA: Separare le guide interne ed esterne del cassetto prima di fissarle ai pannelli.

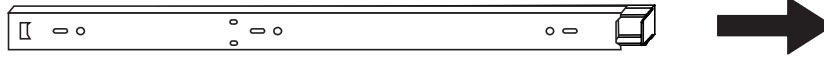

EN_Slide drawer runners apart until the drawer lock can be seen, as shown.

FR_Les glissières de tiroir doivent être ouvertes jusqu'à ce que la serrure du tiroir soit visible, comme indiqué.

ES_Deslice a un lado los rieles del cajón hasta que se pueda ver el cierre del armario, tal y como se muestra.

PT_Deslizam-se as gavetas até?se poder ver o fecho da gaveta, como se mostra.

DE_Schieben Sie die Schubladenführungen auseinander, bis das Schubladenschloss sichtbar ist, gemäß der Abbildung.

IT_Far scorrere le guide del cassetto fino a quando non sia visibile il blocco di scorrimento, come mostrato.



EN_Press and hold the drawer runner lock and then continue to slide drawer runners apart, as shown.

FR_En appuyant et en maintenant le verrouillage des glissières de tiroir, vous pouvez continuer à les écarter l'une de l'autre, comme indiqué.

ES_Mantenga presionado el cierre del riel del cajón y después continúe deslizando a un lado los rieles de los cajones, tal y como se muestra.

PT_Manter pressionado o fecho de gaveta e depois continuar a deslizar as corrediças da gaveta, como mostrado.

DE_Drücken und halten Sie die Verriegelung der Schubladenführung und schieben Sie die Schubladenführungen wie abgebildet weiter auseinander.

IT_Tenere premuto il blocco di scorrimento e quindi continuare a far scorrere la guida, come mostrato.

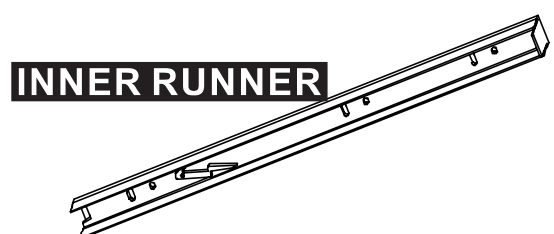
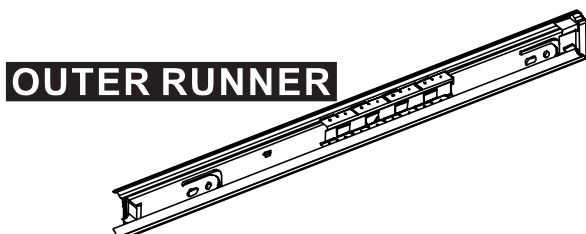
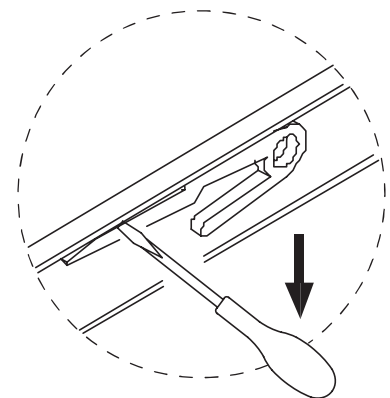

EN_Your inner and outer drawer runners are ready to be fixed to panels.

FR_Il est possible, à présent, de fixer les glissières intérieures et extérieures de vos tiroirs sur des panneaux.

ES_Los rieles interiores y exteriores del cajón están listos para fijarse a los paneles.





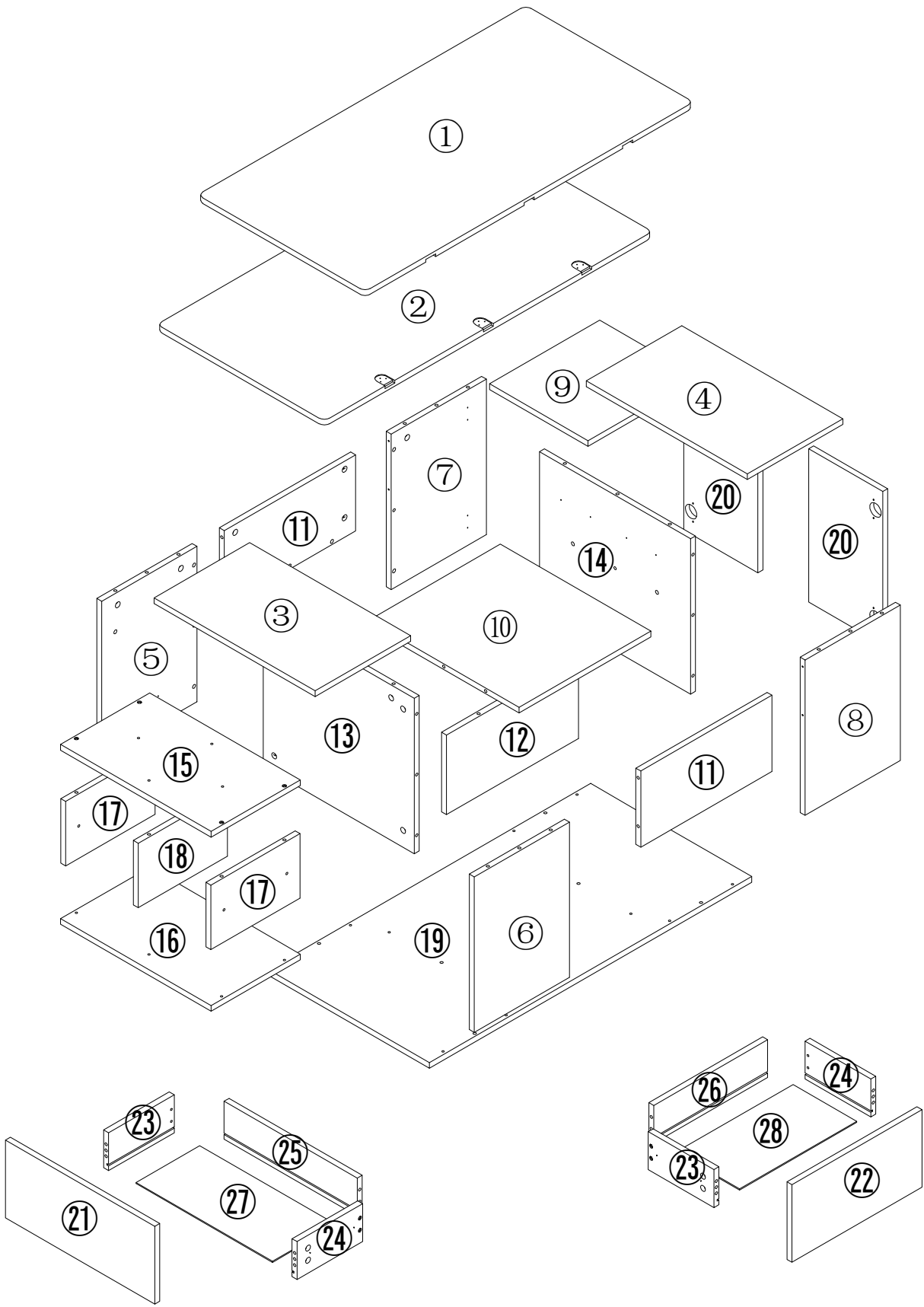

PT_As corrediças das gavetas interiores e exteriores estão prontas para serem fixadas nos painéis.

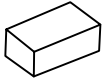
DE_Ihre inneren und äußeren Schubladenführungen sind bereit, an den Platten befestigt zu werden.

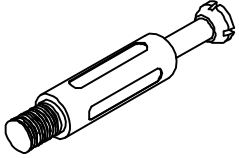
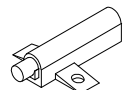
IT_Le guide interne ed esterne sono pronte per essere fissate ai pannelli.

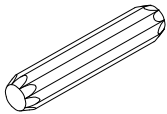
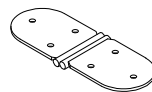
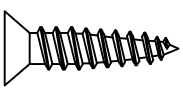

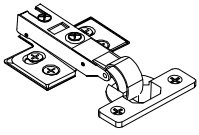
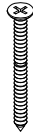
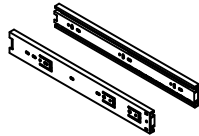
N625P283231W		N625P283232W			
NO.	QTY	NO.	QTY	NO.	QTY
①	1PCS	⑤	1PCS	②②	1PCS
②	1PCS	⑥	1PCS	②③	2PCS
③	1PCS	⑦	1PCS	②④	2PCS
④	1PCS	⑧	1PCS	②⑥	1PCS
⑬	1PCS	⑨	1PCS	Hardware	
⑭	1PCS	⑩	1PCS		
⑮	1PCS	⑪	2PCS		
⑯	1PCS	⑫	1PCS		
⑰	1PCS	⑬	2PCS		
⑳	1PCS	⑭	1PCS		
㉑	1PCS	⑮	2PCS		
㉒	1PCS	⑯	1PCS		
㉓	1PCS	⑰	2PCS		
㉔	1PCS	⑱	2PCS		
㉕	1PCS	㉑	1PCS		

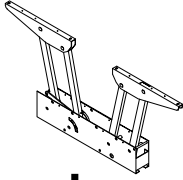
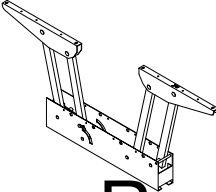
<p>A</p>  <p>44PCS</p>	<p>G</p>  <p>4PCS</p>
<p>B</p>  <p>44PCS</p>	<p>H</p>  <p>6PCS</p>
<p>C</p>  <p>28PCS</p>	<p>J</p>  <p>3PCS</p>
<p>D</p>  <p>70PCS</p>	<p>K</p>  <p>12PCS</p>
<p>E</p>  <p>4PCS</p>	<p>N</p>  <p>20PCS</p>
<p>F</p>  <p>200mm</p> <p>2SET</p>	<p>M</p>  <p>18PCS</p>
<p>L</p> 	<p>R</p>  <p>1PCS</p>

1

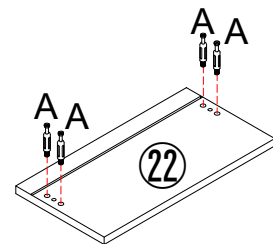
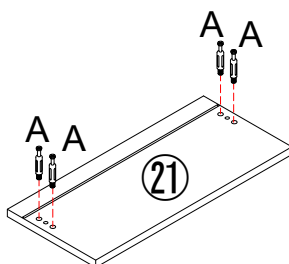
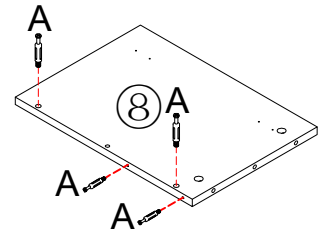
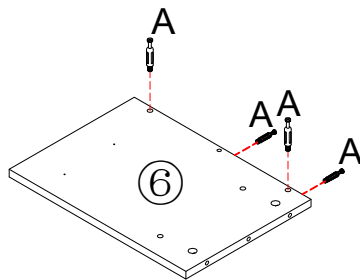
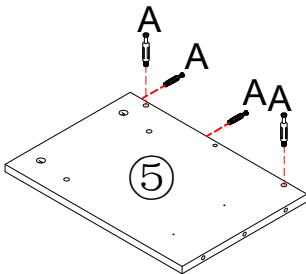
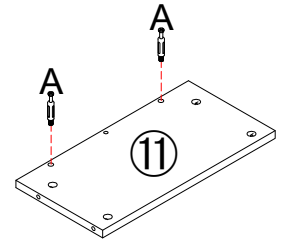
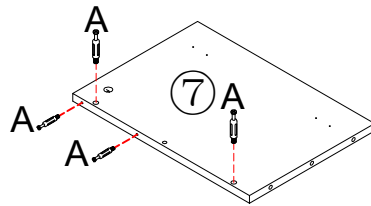
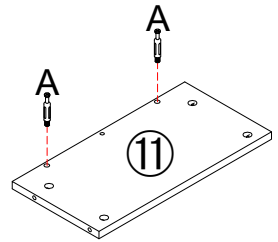
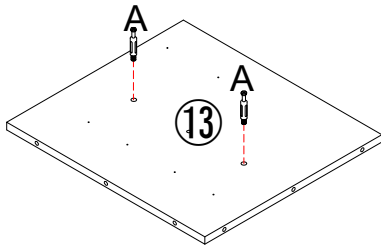
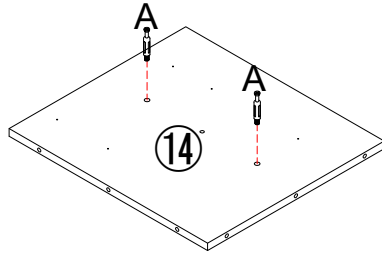
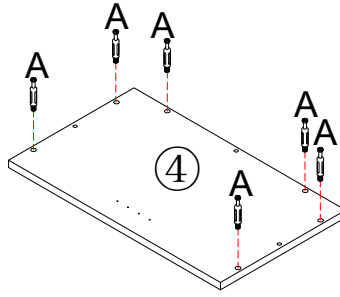
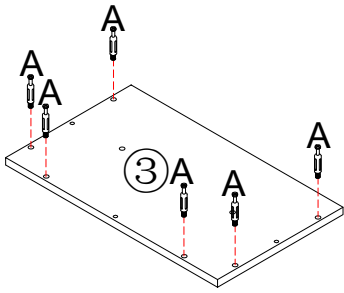
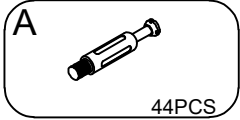

2

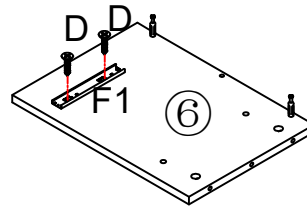
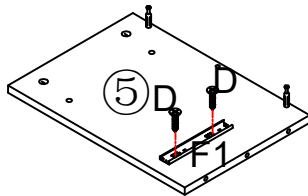
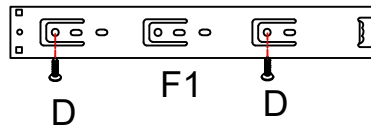
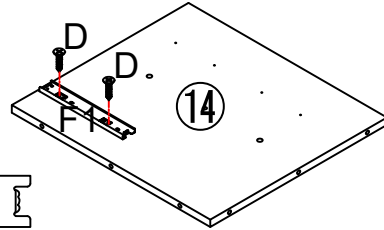
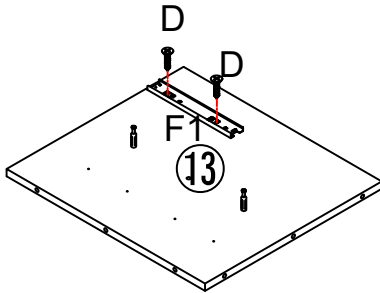
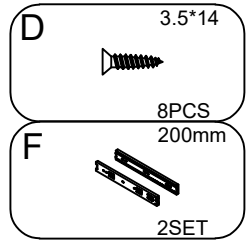
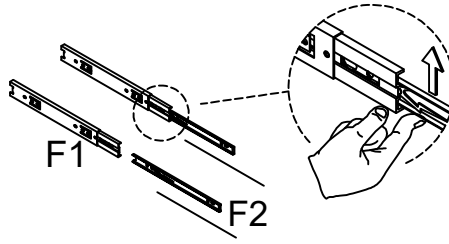

3

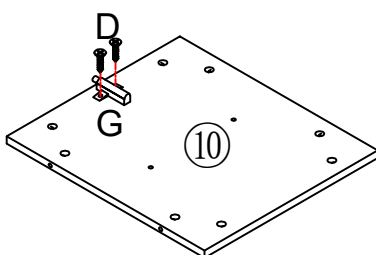
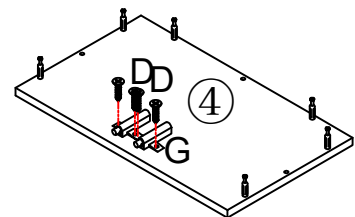
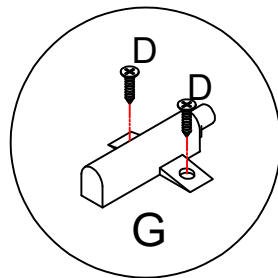
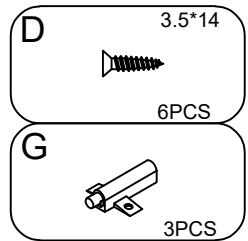
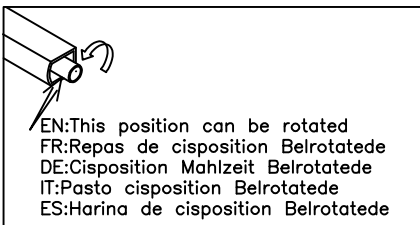

DE:

Wenn Sie auf eine Schublade oder T?r dr?cken und siesich nicht ?ffnet,versuchen Sie,das Teil gegen den Uhrzeigersinn zu drehen,und wenn siesich nicht schlieBt,machen Sie das Gegenteil.

EN:

If you push on a drawer or door and it doesn't pop out,try turning the part counterclockwise,and if it won't close,do the opposite.

IT:

Se spingi su un cassetto o una porta e non si apre,prova a girare la parte in senso antiorario,e se non si chiude,fai il contrario.

FR:

Si vous poussez sur un tiroir ou une porte et qu'il ne s'ouvre pas,essayez de tourner la pi?cedans le sens inverse des aiguilles d'une montre,et s'il ne se ferme pas,faites le contraire.

ES:

Si empujas un caj?n o una pueratay no se abre,intentagirar la pieza en sentido contrario a las agujas del reloj,y si no se cierra,haz lo contrario.

4

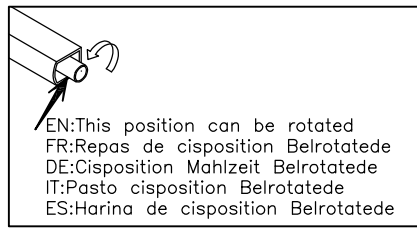
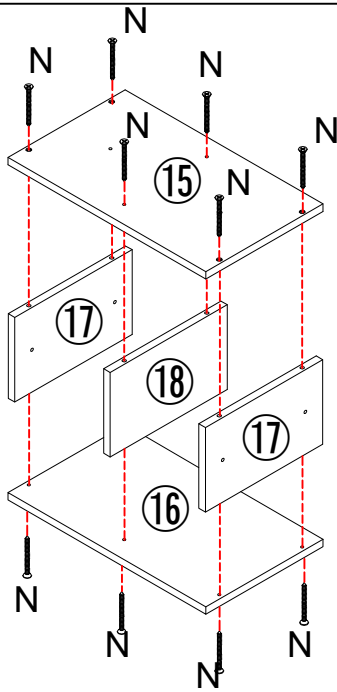

180°

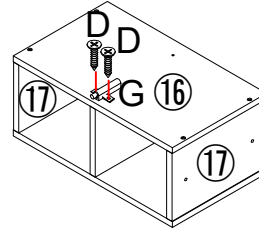

N	3.5*35		12PCS
D	3.5*14		2PCS
G			1PCS

DE: Wenn Sie auf eine Schublade oder Tür drücken und sie sich nicht öffnet, versuchen Sie, das Teil gegen den Uhrzeigersinn zu drehen, und wenn sie sich nicht schließt, machen Sie das Gegenteil.

EN: If you push on a drawer or door and it doesn't pop out, try turning the part counterclockwise, and if it won't close, do the opposite.

IT: Se spingi su un cassetto o una porta e non si apre, prova a girare la parte in senso antiorario, e se non si chiude, fai il contrario.

FR: Si vous poussez sur un tiroir ou une porte et qu'il ne s'ouvre pas, essayez de tourner la pièce dans le sens inverse des aiguilles d'une montre, et s'il ne se ferme pas, faites le contraire.

ES: Si empujas un cajón o una puerta y no se abre, intenta girar la pieza en sentido contrario a las agujas del reloj, y si no se cierra, haz lo contrario.

5

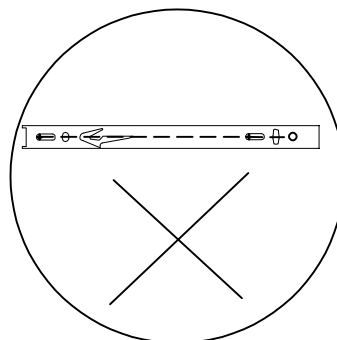
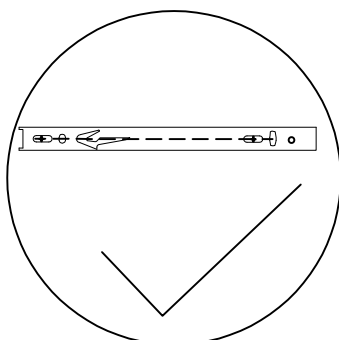
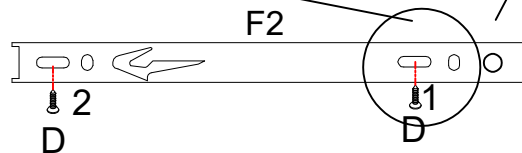
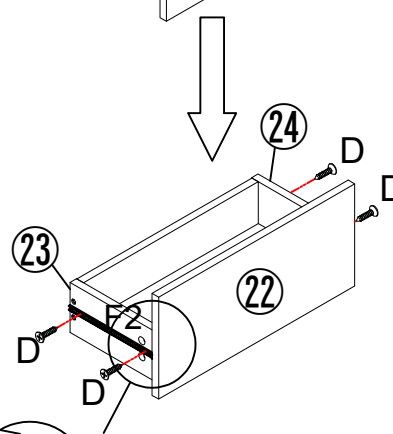
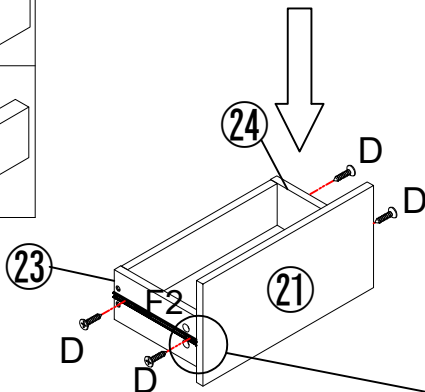
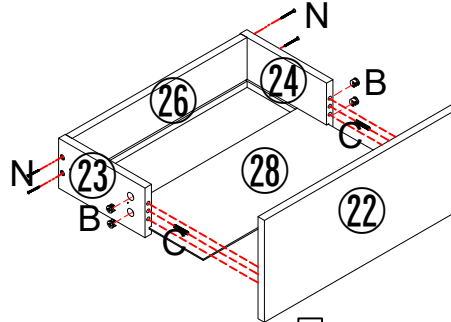
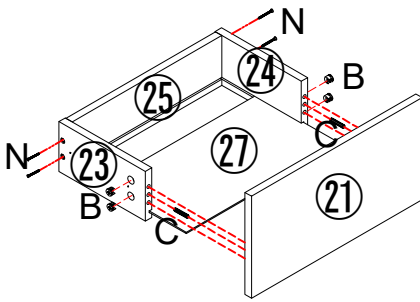
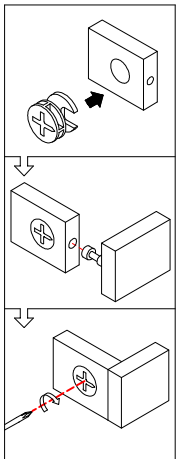

B			8PCS
C	8*40		4PCS
D	3.5*14		8PCS
F	200mm		2SET
N	3.5*35		8PCS

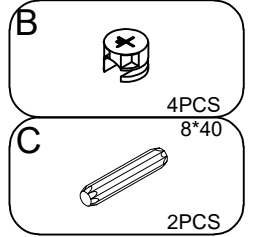
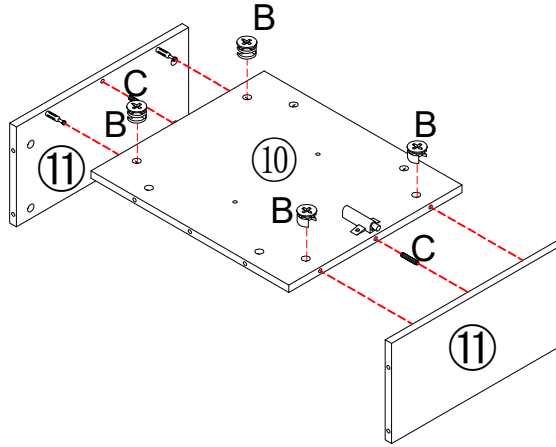
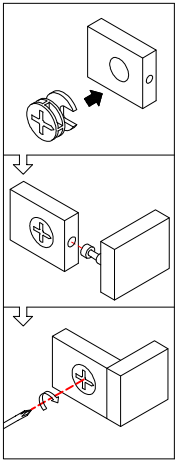

6

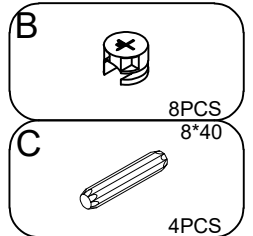
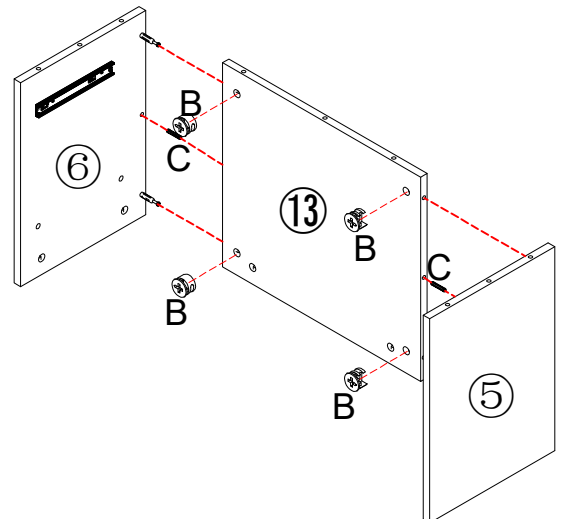
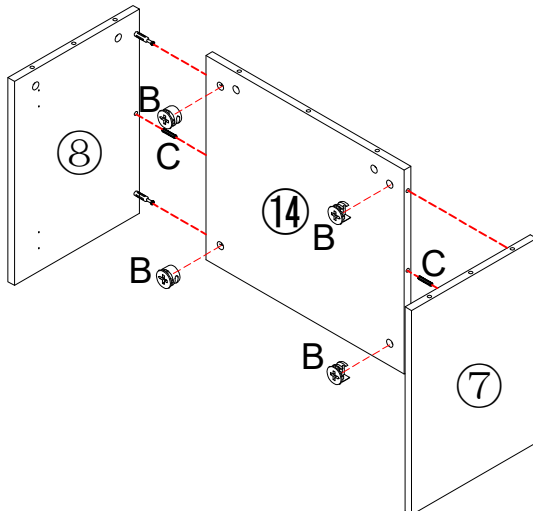
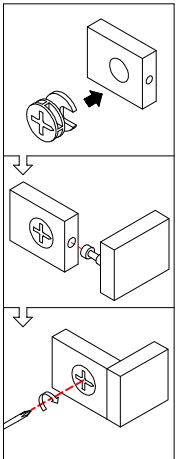

7



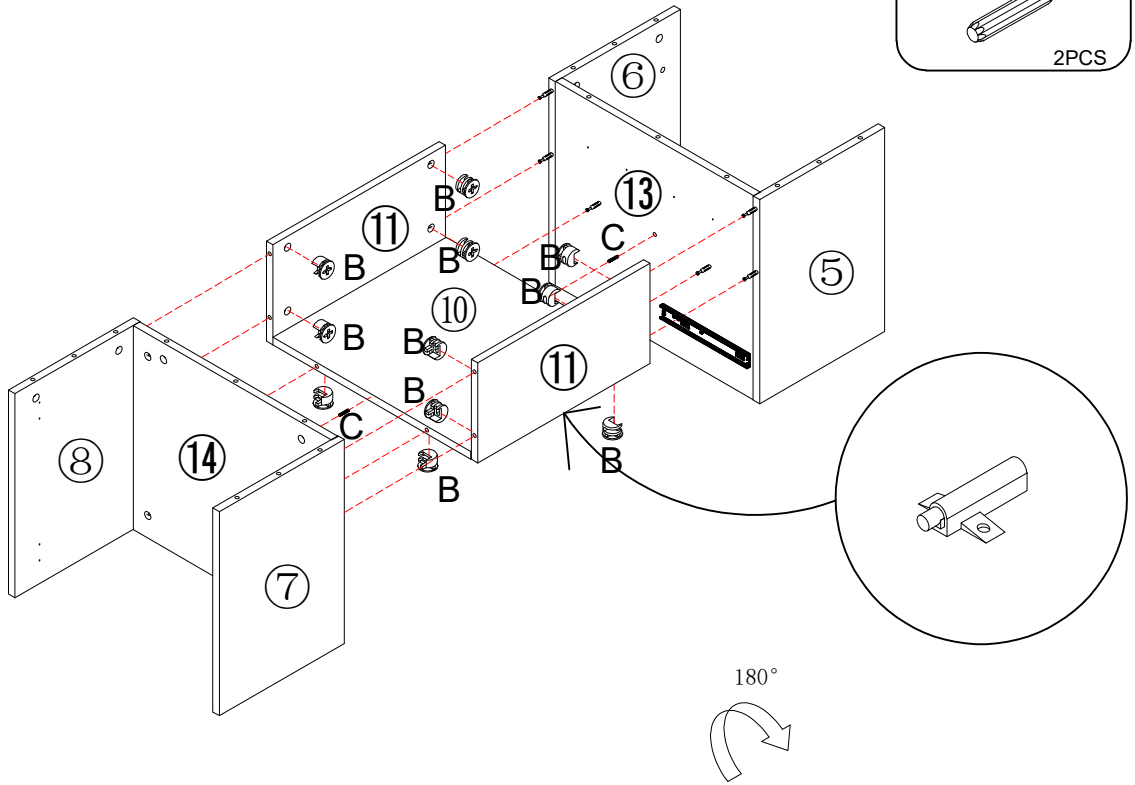
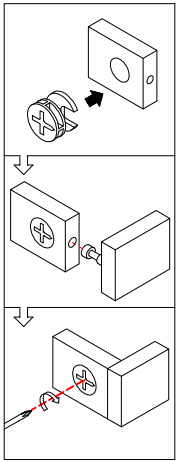

8

- B  12PCS
8*40
- C  2PCS



9

- K  12PCS
5*40
- C  10PCS
8*40

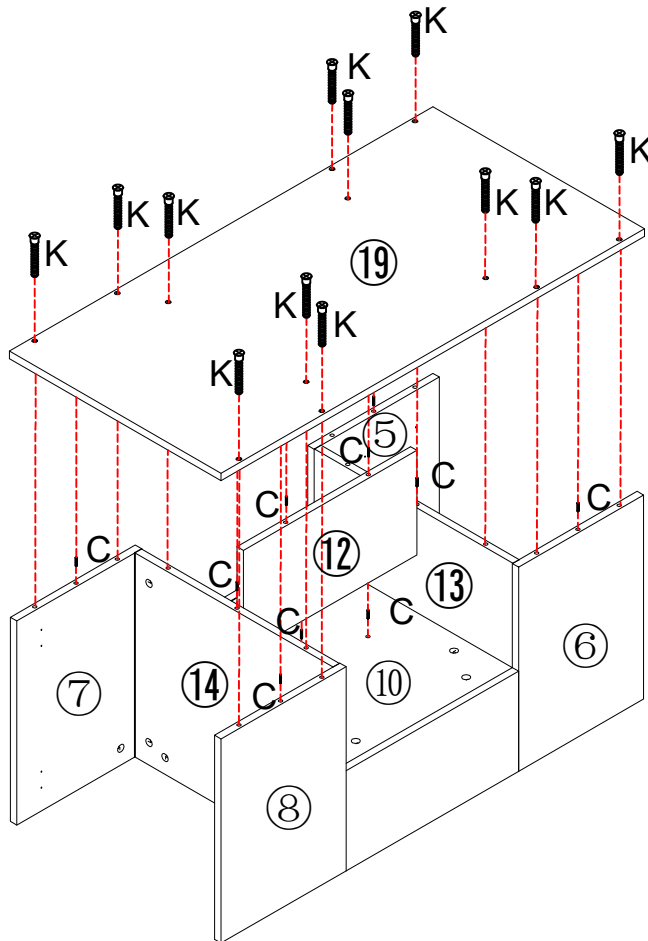

10

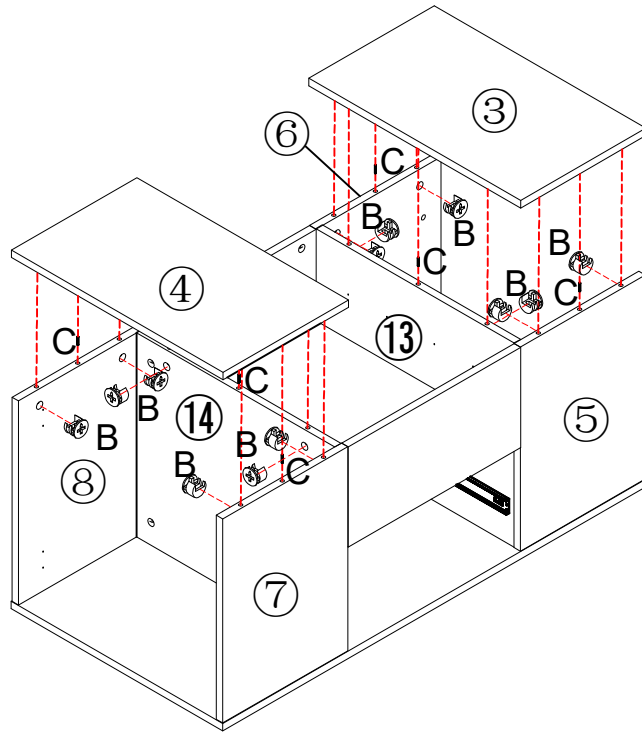
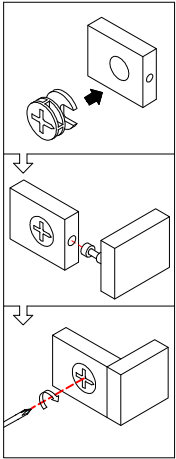
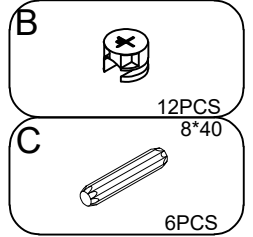

11

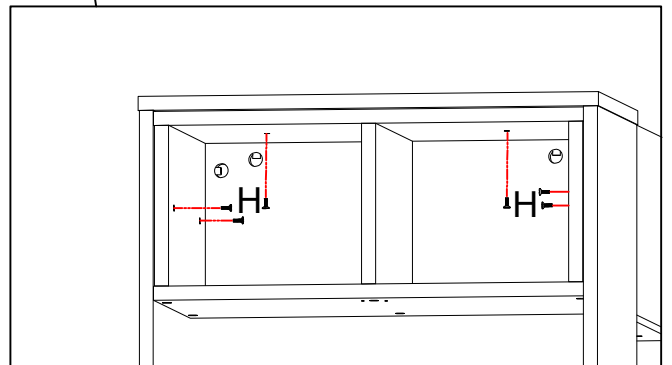
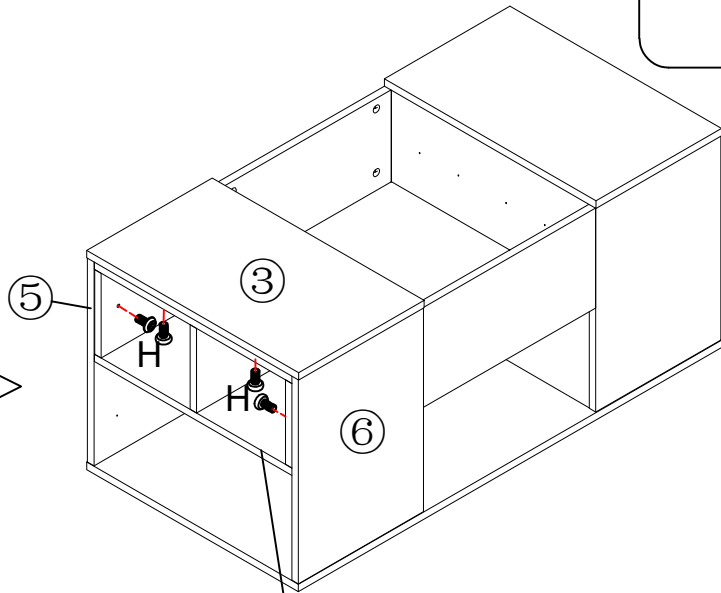
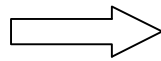
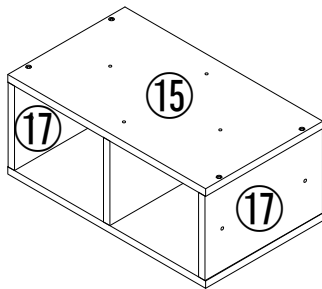
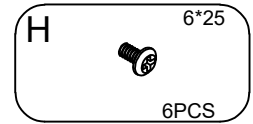

12

D 3.5*14
8PCS

E
4PCS

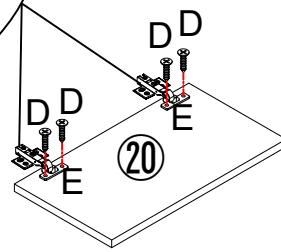
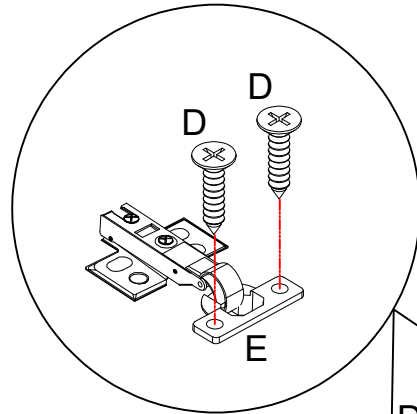

X2

13

D 3.5*14
16PCS

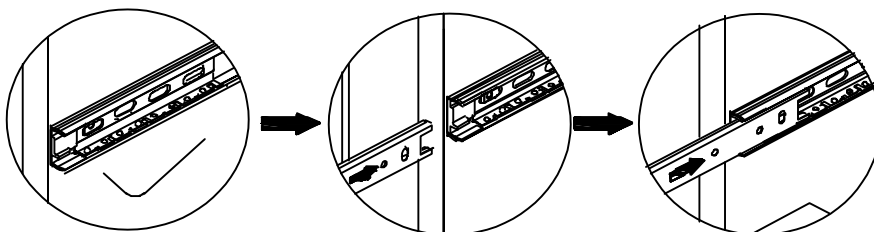
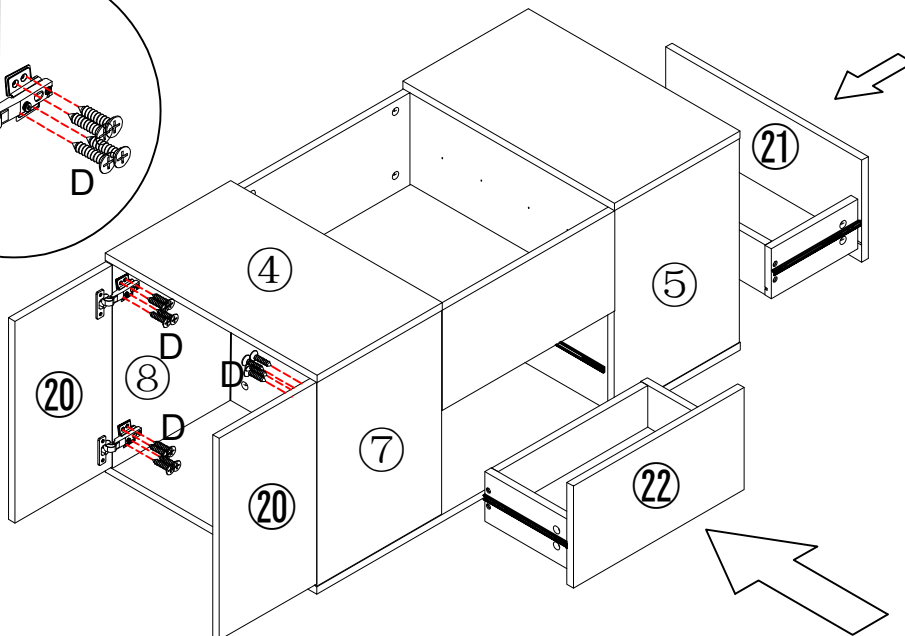
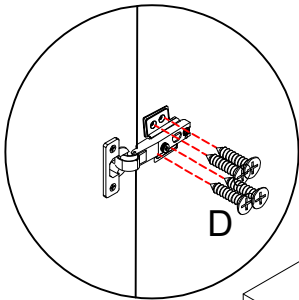

Achtung!!

Attention!!

Attenzione!!

Attention!!

Atención!!

Bitte bewegen Sie dieses Teil in den folgenden Installationsschritten nicht auf diese Weise, um ein Ablösen der Tischplatte zu vermeiden.

In the subsequent installation steps, please do not move this part like this to prevent the tabletop from coming loose.

Nei passaggi successivi dell'installazione, si prega di non spostare questa parte in questo modo per evitare che il piano del tavolo si stacchi.

Dans les étapes d'installation suivantes, veuillez ne pas déplacer cette pièce de cette manière pour éviter que le plateau de la table ne se détache.

En los siguientes pasos de instalación, por favor no mueva esta parte de esta manera para evitar que la tabla se desprenda.

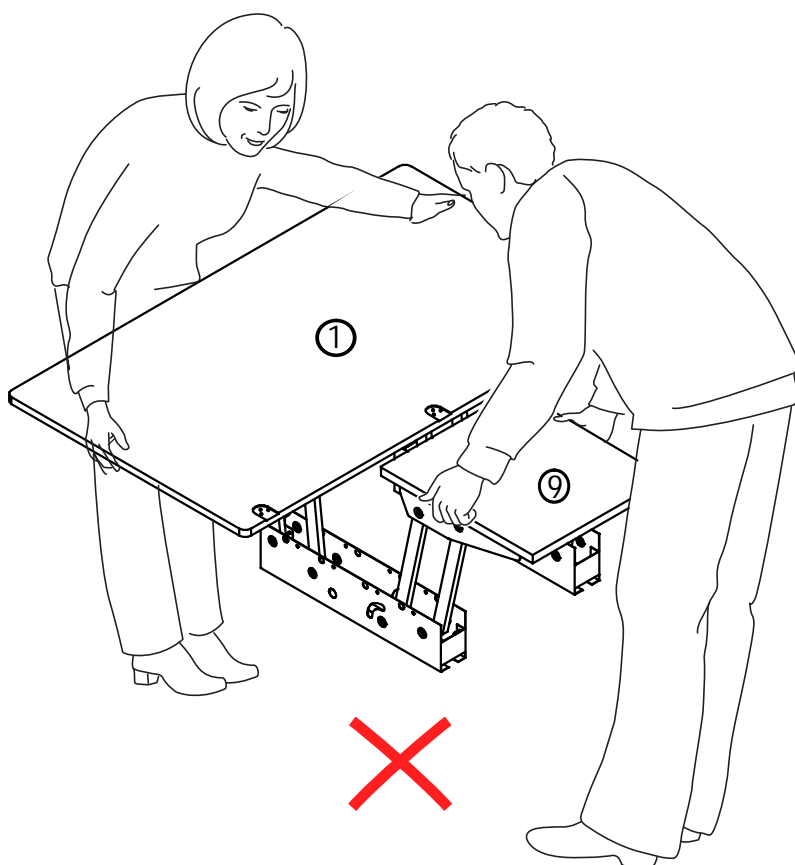
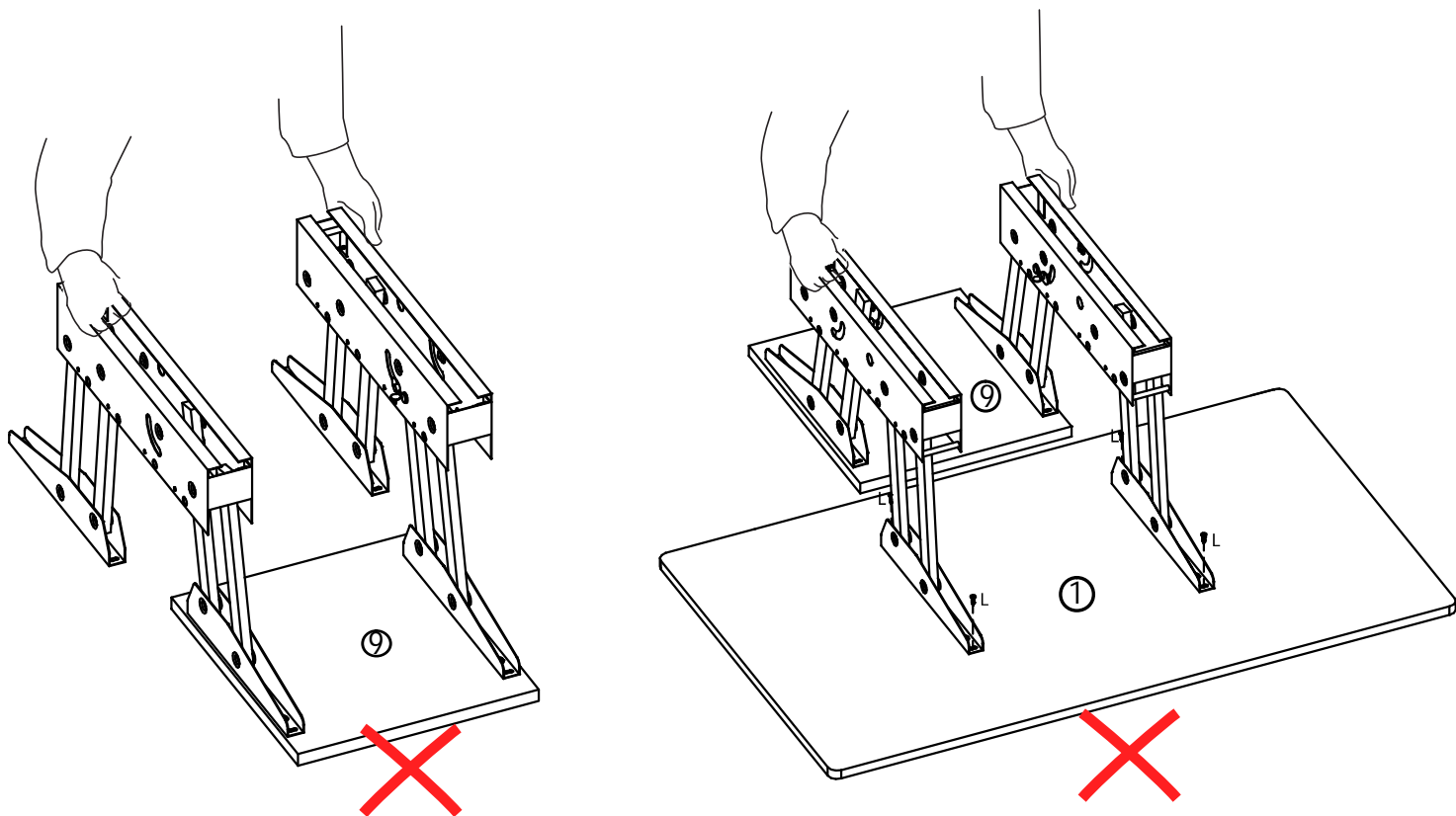

14

J  3PCS
3.5*12

M  18PCS

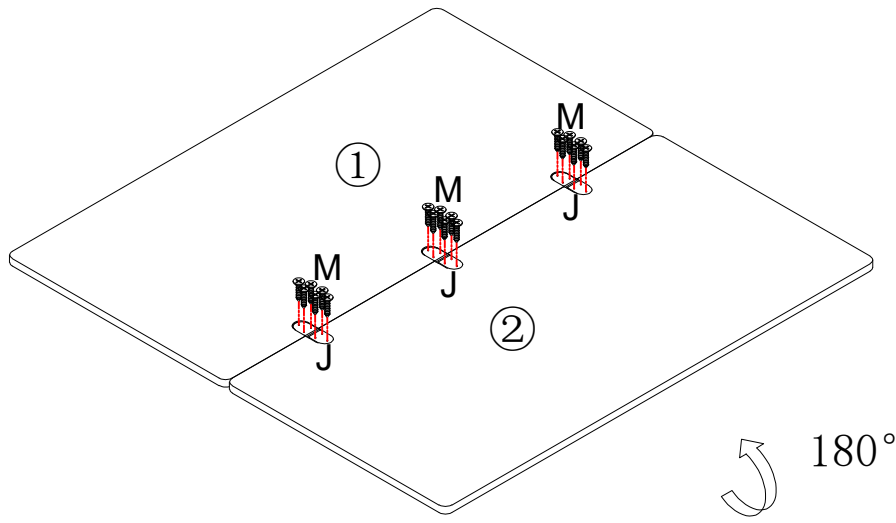

15



D  8PCS
3.5*14

L  1PCS

R  1PCS

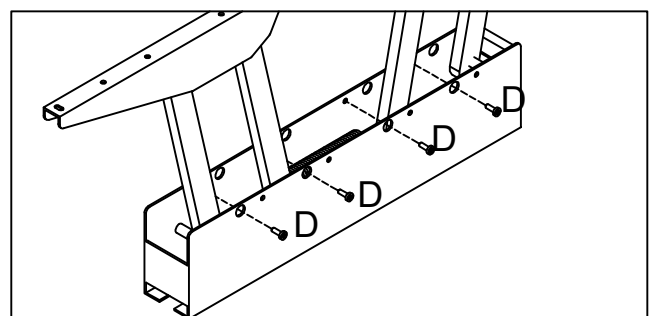
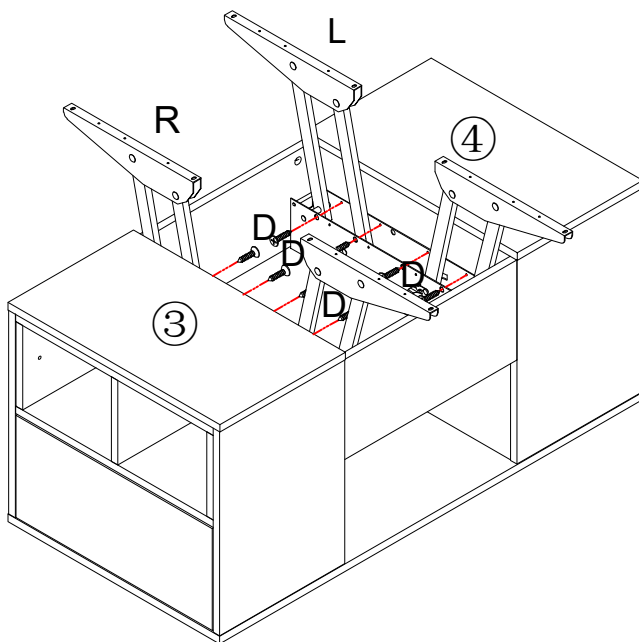

16

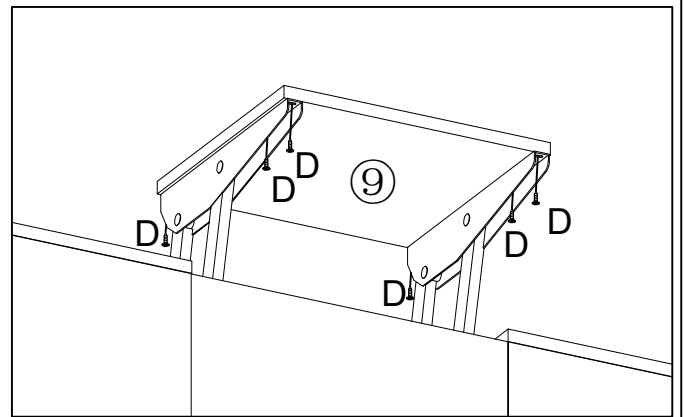
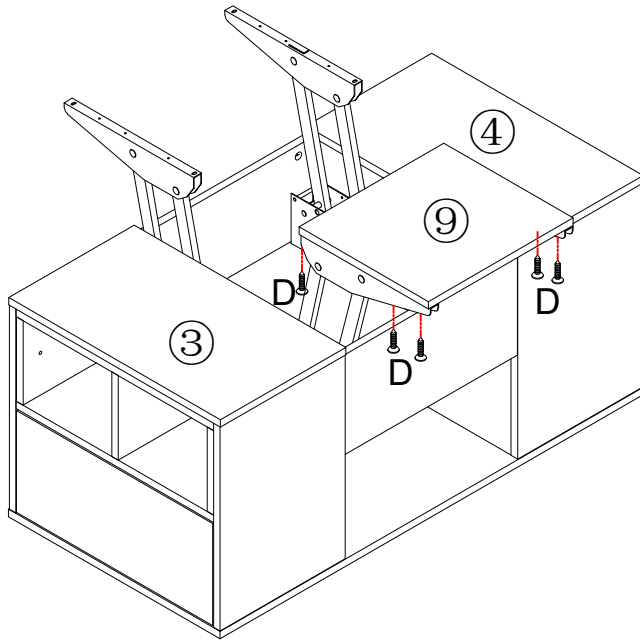
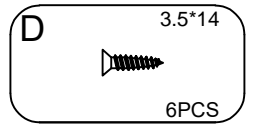

17

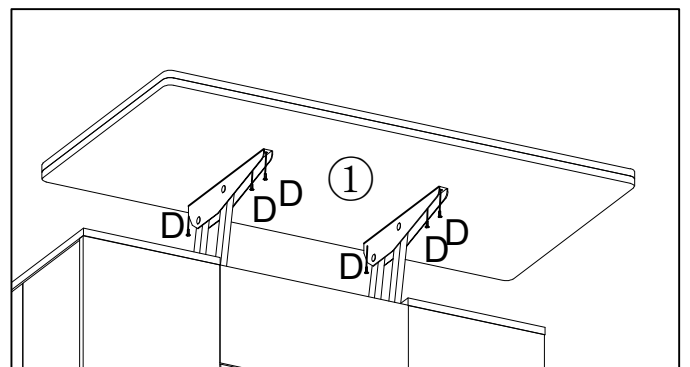
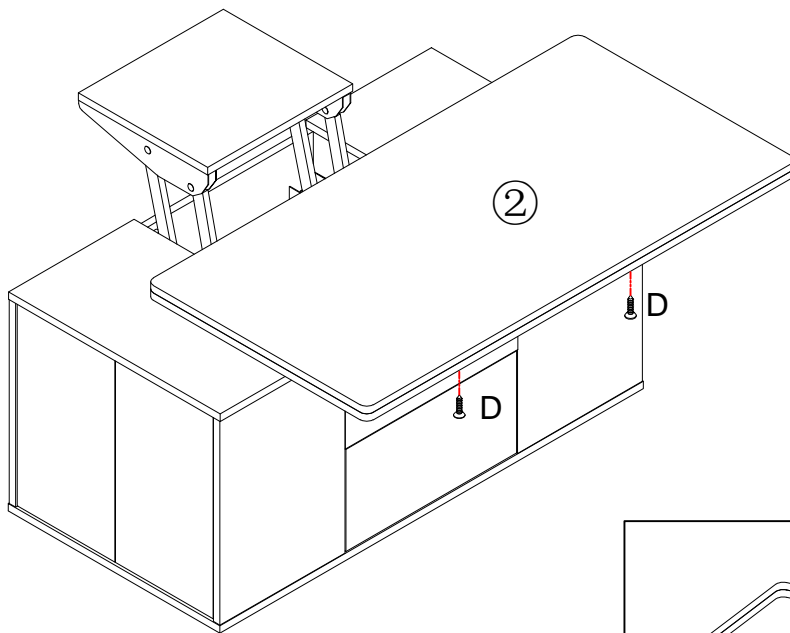
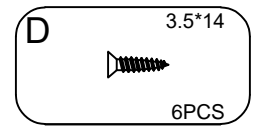

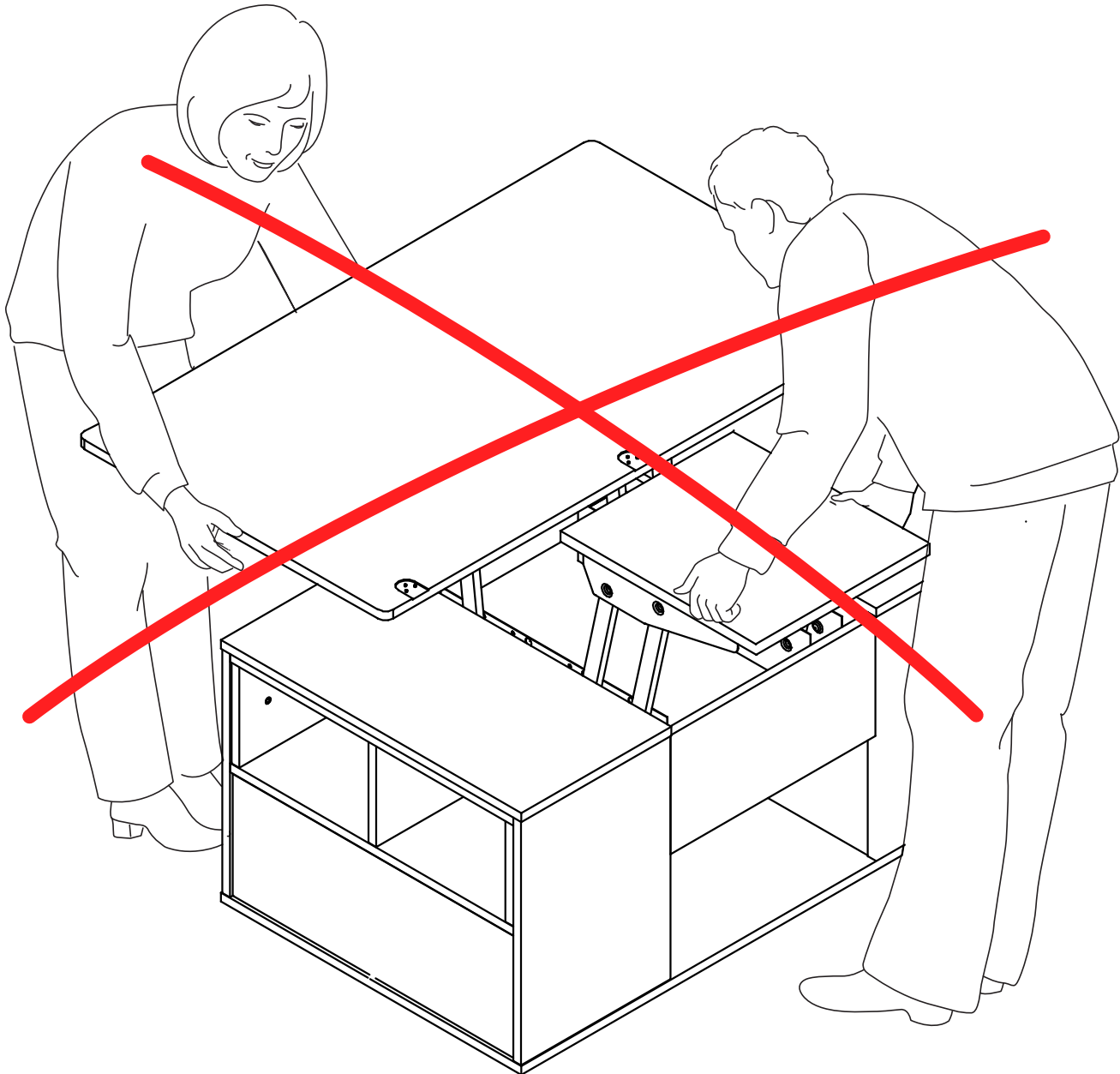

"After installation, please do not move the entire table this way to avoid the tabletop falling off."

"Nach der Installation bewegen Sie bitte den gesamten Tisch nicht auf diese Weise, um ein Abfallen der Tischplatte zu vermeiden."

"Dopo l'installazione, si prega di non muovere l'intero tavolo in questo modo per evitare che il piano del tavolo cada."

"Après l'installation, veuillez ne pas déplacer la table entière de cette manière pour éviter que le plateau ne tombe."

"Después de la instalación, por favor no mueva toda la mesa de esta manera para evitar que la tapa se caiga."

