

N625P254360

Product manual
Gebrauchsanweisung
Manuel du produit
Manual del producto
Manuale del prodotto

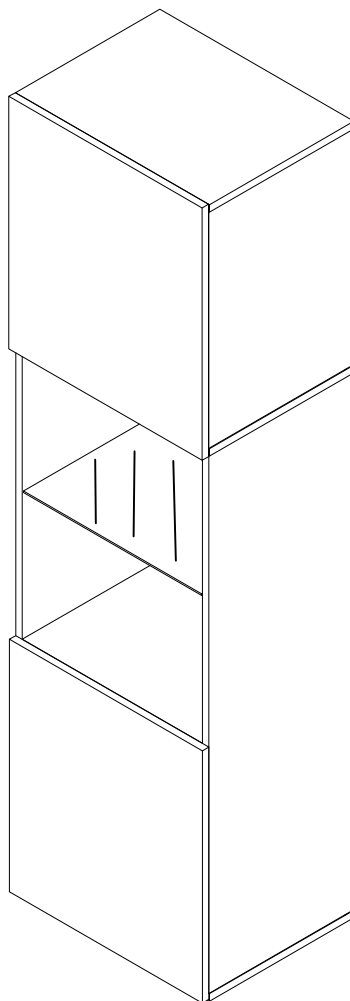

Importeur	Decobus Handel GmbH
Adresse	Innungsstraße 9, 21244 Buchholz, Deutschland
URL	https://www.decobusgroup.de
Hersteller	Qingdao Modeng Home Furnishing Co.,Ltd
Adresse	Vanke Taohuayuan 3, Taicheng Road, Chengyang District, Qingdao city, Shandong province.
Email/URL	Frank_hfmy@163.com
	Decobus Handel GmbH Innungsstraße 9, 21244 Buchholz, Deutschland https://www.decobusgroup.de

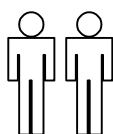

2PERS

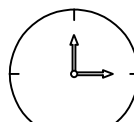

60MIN

Tool Required Not Provided

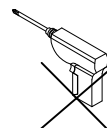

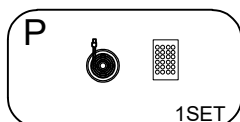
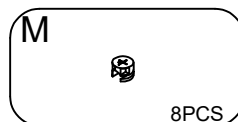
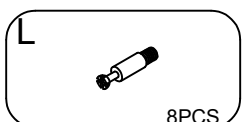
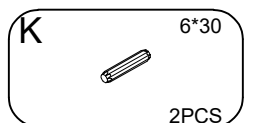
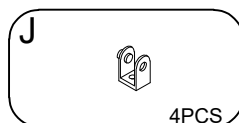
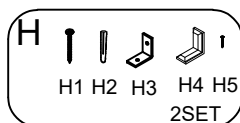
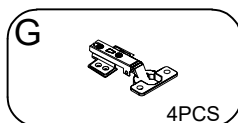
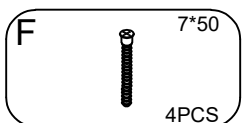
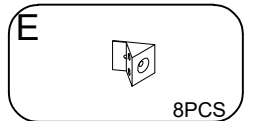
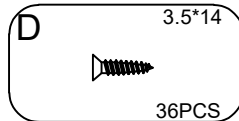
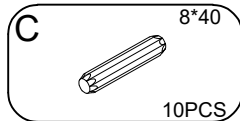
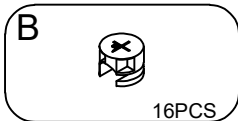
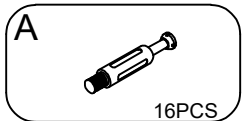
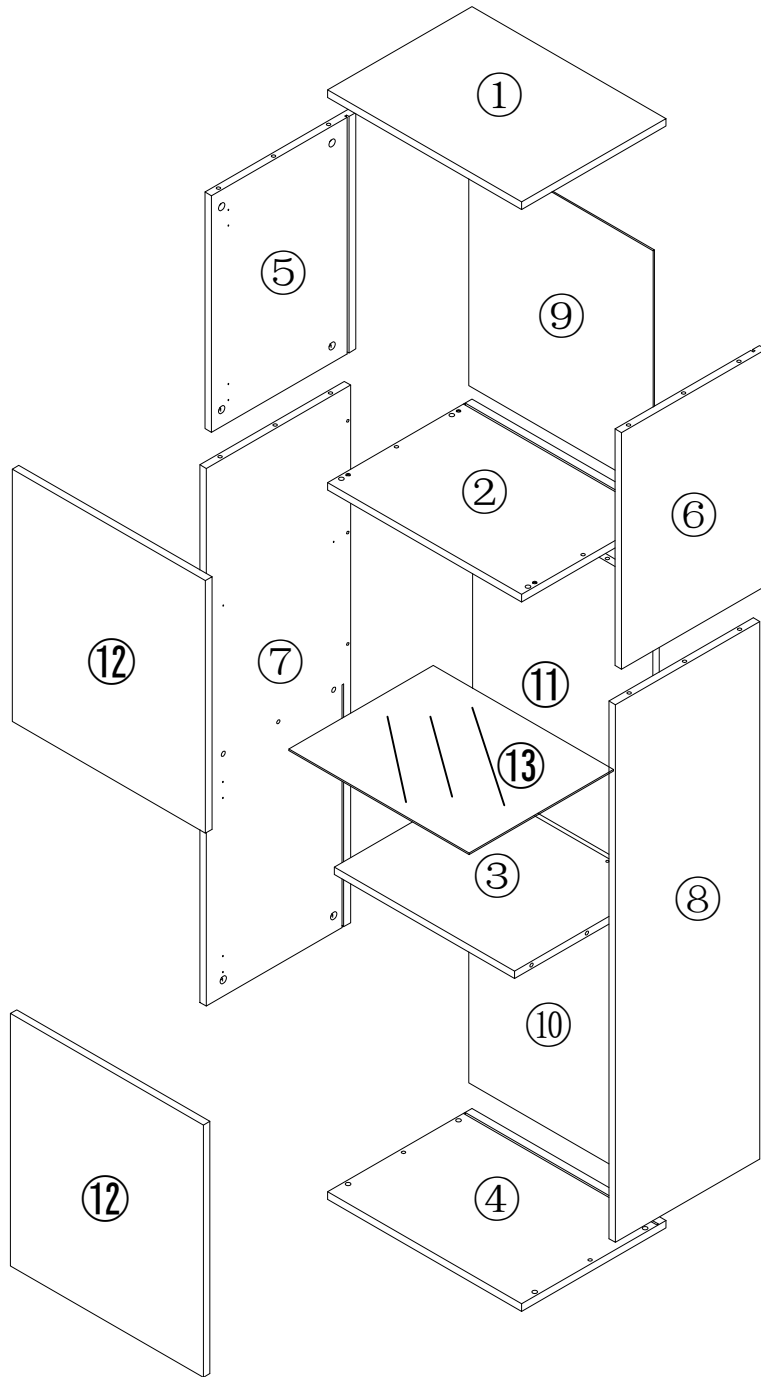

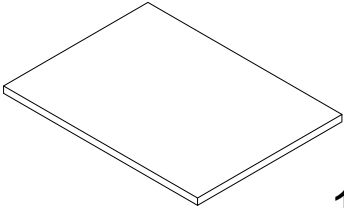
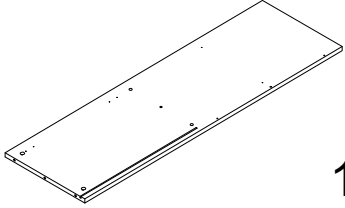
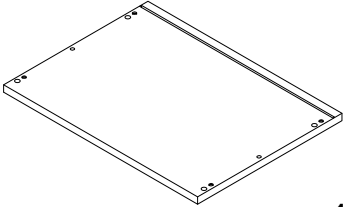
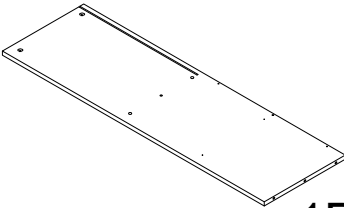
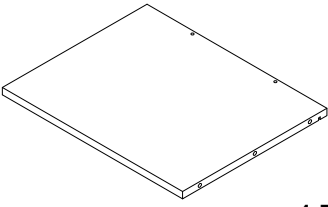
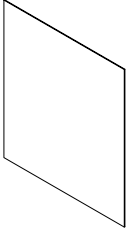
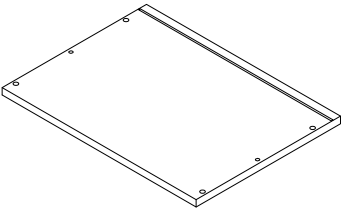
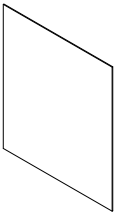
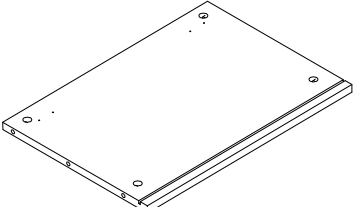
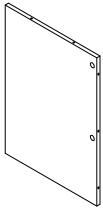
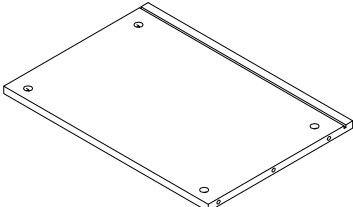
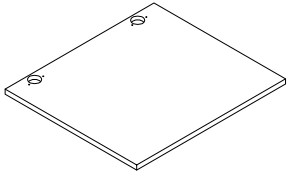
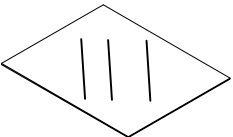
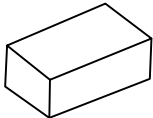
N625P254360S		N625P254360W	
NO.	QTY	NO.	QTY
①	 1PCS	⑦	 1PCS
②	 1PCS	⑧	 1PCS
③	 1PCS	⑨	 1PCS
④	 1PCS	⑩	 1PCS
⑤	 1PCS	⑪	 1PCS
⑥	 1PCS	⑫	 2PCS
⑬	 1PCS	Hardware	



[DE]

Warnung: Lesen Sie diese Anleitung vor dem Zusammenbau bitte vollständig durch. Überprüfen Sie, ob Sie alle auf den Seiten aufgeführten Komponenten und Werkzeuge haben. Bewahren Sie die Anleitung zum späteren Nachschlagen auf. Teile des Zusammenbaus lassen sich mit 2 Personen leichter durchführen. Suchen Sie bei Bedarf professionelle Hilfe.

Warnung: Legen Sie alle Teile auf eine ebene Fläche. Legen Sie eine weiche Decke oder Ähnliches darunter, um sie vor Kratzern oder Flecken zu schützen. Vermeiden Sie es, Komponenten über den Boden zu ziehen oder zu schieben.

Warnung: Überprüfen Sie regelmäßig alle Beschläge und Befestigungen, um sicherzustellen, dass sie sicher sind und um Unfälle zu vermeiden. Wenn Teile fehlen, kaputt, beschädigt oder abgenutzt sind, verwenden Sie das Produkt nicht weiter, bis es mit vom Hersteller autorisierten Teilen repariert wurde.

Warnung: Lassen Sie Kinder nicht auf die Möbel klettern, da dies zum Umkippen und zu schweren Verletzungen führen kann. Bauen Sie die Möbel außerhalb der Reichweite von Kindern zusammen.

Warnung: Stellen Sie die Möbel nicht in die Nähe von Feuerquellen oder heißen Gegenständen, um Brandgefahr zu vermeiden.

Warnung: Reinigen Sie die Möbel mit einem feuchten Tuch oder Alkohol. Verwenden Sie keine Reinigungsmittel mit ätzenden Chemikalien.

Warnung: Dieses Produkt ist mit einer Kippschutzvorrichtung ausgestattet. Bitte installieren Sie diese Vorrichtung unbedingt, um unnötige Verletzungen durch Umkippen zu vermeiden.

[EN]

Warning: Please read these instructions fully before starting assembly. Check you have all the components and tools listed on pages. Keep the instructions for later reference. Parts of the assembly will be easier with 2 people. Seek professional assistance if necessary.

Warning: Please place all parts on a flat surface. Place a soft blanket or similar underneath to protect against scratches or stains. Avoid dragging or sliding components across the floor.

Warning: Regularly check all fittings and fastenings to ensure they are secure and to prevent accidents. If any parts are missing, broken, damaged, or worn, discontinue use of the product until repairs have been made using factory authorized parts.

Warning: Do not allow children to climb on the furniture as this may result in tipping and serious personal injury. Assemble the furniture away from the reach of children.

Warning: Do not place furniture close to fire sources or high-temperature objects to avoid the risk of fire. Do not place furniture in damp environments to prevent material damage.

Warning: Clean furniture with a damp cloth or alcohol, avoid using cleaning agents containing corrosive chemicals.

Warning: This product is equipped with an anti-tilt device. Please be sure to install this device to prevent unnecessary injuries caused by tipping.

[FR]

Avertissement : Veuillez lire attentivement ces instructions avant de commencer l'assemblage. Vérifiez que vous disposez de tous les composants et outils répertoriés sur les pages. Conservez les instructions pour référence ultérieure. Certaines parties de l'assemblage seront plus faciles à 2 personnes. Demandez l'aide d'un professionnel si nécessaire.

Avertissement : Veuillez placer toutes les pièces sur une surface plane. Placez une couverture douce ou similaire en dessous pour les protéger des rayures ou des taches. Évitez de faire glisser les composants sur le sol.

Avertissement : Vérifiez régulièrement tous les raccords et fixations pour vous assurer qu'ils sont bien fixés et

pour éviter les accidents. Si des pièces manquent, sont cassées, endommagées ou usées, cessez d'utiliser le produit jusqu'à ce que des réparations aient été effectuées à l'aide de pièces autorisées par l'usine.

Avertissement : Ne laissez pas les enfants grimper sur les meubles car cela pourrait entraîner un basculement et des blessures graves. Assemblez les meubles hors de portée des enfants.

Avertissement : Ne placez pas les meubles à proximité de sources de feu ou d'objets à haute température pour éviter tout risque d'incendie.

Avertissement : Nettoyez les meubles avec un chiffon humide ou de l'alcool, évitez d'utiliser des produits de nettoyage contenant des produits chimiques corrosifs.

Avertissement : Ce produit est équipé d'un dispositif anti-basculement. Assurez-vous d'installer ce dispositif pour éviter les blessures inutiles causées par un basculement.

[IT]

Attenzione: leggere attentamente queste istruzioni prima di iniziare il montaggio. Verificare di avere tutti i componenti e gli strumenti elencati nelle pagine. Conservare le istruzioni per riferimento futuro. Alcune parti del montaggio saranno più facili con 2 persone. Se necessario, chiedere assistenza professionale.

Attenzione: posizionare tutte le parti su una superficie piana. Posizionare una coperta morbida o simile sotto per proteggere da graffi o macchie. Evitare di trascinare o far scivolare i componenti sul pavimento.

Attenzione: controllare regolarmente tutti i raccordi e i dispositivi di fissaggio per assicurarsi che siano sicuri e per prevenire incidenti. Se alcune parti sono mancanti, rotte, danneggiate o usurate, interrompere l'uso del prodotto fino a quando non siano state eseguite le riparazioni utilizzando parti autorizzate dalla fabbrica.

Attenzione: non consentire ai bambini di arrampicarsi sui mobili poiché ciò potrebbe causare ribaltamenti e gravi lesioni personali. Montare i mobili lontano dalla portata dei bambini.

Attenzione: non posizionare i mobili vicino a fonti di fuoco o oggetti ad alta temperatura per evitare il rischio di incendio

Attenzione: pulire i mobili con un panno umido o alcol, evitare di utilizzare detergenti contenenti sostanze chimiche corrosive.

Attenzione: questo prodotto è dotato di un dispositivo antiribaltamento. Assicurarsi di installare questo dispositivo per prevenire lesioni inutili causate dal ribaltamento.

[ES]

Advertencia: Lea estas instrucciones completamente antes de comenzar el montaje. Compruebe que tiene todos los componentes y herramientas que se enumeran en las páginas. Conserve las instrucciones para consultarlas más adelante. El montaje de algunas partes será más sencillo con 2 personas. Busque ayuda profesional si es necesario.

Advertencia: Coloque todas las piezas sobre una superficie plana. Coloque una manta suave o algo similar debajo para protegerlas de rayones o manchas. Evite arrastrar o deslizar los componentes por el piso.

Advertencia: Verifique regularmente todos los accesorios y fijaciones para asegurarse de que estén seguros y evitar accidentes. Si falta alguna pieza, está rota, dañada o desgastada, deje de usar el producto hasta que se hayan realizado las reparaciones con piezas autorizadas de fábrica.

Advertencia: No permita que los niños se suban a los muebles, ya que esto puede provocar que se vuelquen y lesiones personales graves. Monte los muebles fuera del alcance de los niños.

Advertencia: No coloque los muebles cerca de fuentes de fuego u objetos de alta temperatura para evitar el riesgo de incendio.

Advertencia: Limpie los muebles con un paño húmedo o alcohol, evite usar agentes de limpieza que contengan químicos corrosivos.

Advertencia: Este producto está equipado con un dispositivo antivuelco. Asegúrese de instalar este dispositivo para evitar lesiones innecesarias causadas por vuelcos.

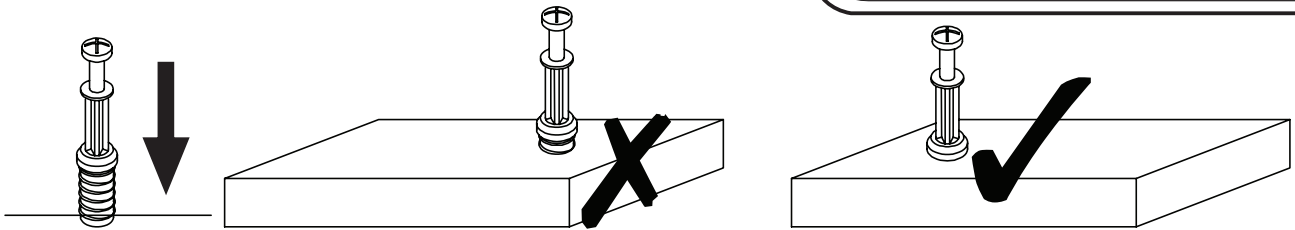

EN_QUICKFIT: Tighten quickfit until shoulder is flush with panel. Do not overtighten or undertighten.

FR_RACCORD RAPIDE: Faites serrer le raccord rapide jusqu'à ce que l'épaulement soit parfaitement encastré dans le panneau. Il ne faut ni trop serrer ni insuffisamment serrer.

ES_QUICKFIT: Apriete quickfit hasta que el hombro se descargue con el panel. NO lo sobreapriete ni lo apriete poco.

DE_QUICKFIT: Ziehen Sie den Quickfit fest, bis die Schulter mit der Platte bündig ist. Bitte nicht zu fest oder zu schwach anziehen.

IT_MONTAGGIO RAPIDO: Stringere il montaggio rapido fino a quando la spalla è a filo con il pannello, non stringere troppo o troppo poco.

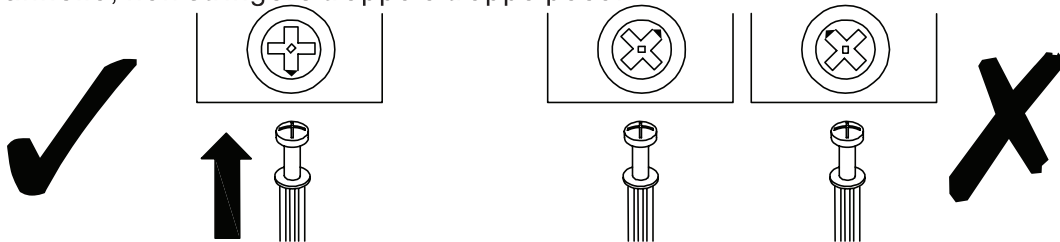

EN_CAM LOCK: When fitting cam lock, ensure starting position is correct before you insert connecting quickfit.

FR_SERRURE BATTEUSE: Avant d'insérer la serrure batteuse, veillez à la bonne orientation avant d'insérer le raccord rapide.

ES_CIERRE DE LA CÁMARA: Cuando instale el cierre de la cámara, asegúrese de que la posición de inicio es correcta antes de que inserte el quickfit conector.

DE_CAM-LOCK: Achten Sie bei der Montage des Cam-Locks auf die richtige Ausgangsposition, bevor Sie den Quickfit einsetzen.

IT_BLOCCAGGIO A CAMMA: Quando si monta il bloccaggio a camma, assicurarsi che la posizione iniziale sia corretta prima di inserire il montaggio rapido di collegamento.

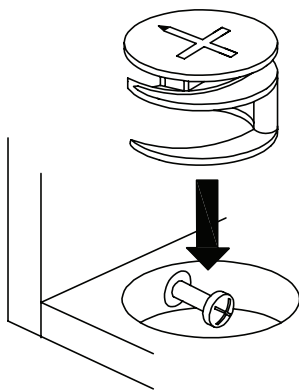

EN_Quickfit head should be in the centre of the cam lock when the two panels are joined.

Cam lock should be inserted before quickfit.

FR_Lorsque les deux panneaux sont assemblés, la tête du raccord rapide doit reposer au centre de la serrure batteuse. Il faut insérer la serrure batteuse avant le raccord rapide.

ES_El cabezal del quickfit debe estar en el centro del cierre de la cámara cuando se unan los dos paneles.

Se debe insertar el cierre de la cámara antes que el quickfit.

DE_Der Quickfit-Kopf sollte sich in der Mitte des Cam-Locks befinden, wenn die beiden Platten zusammengefügt sind. Der Cam-Lock sollte vor dem Quickfit eingesetzt werden.

IT_La testa del montaggio rapido deve trovarsi al centro del bloccaggio a camma quando i due pannelli sono uniti.

Il Bloccaggio a Camma deve essere inserito prima del montaggio rapido.

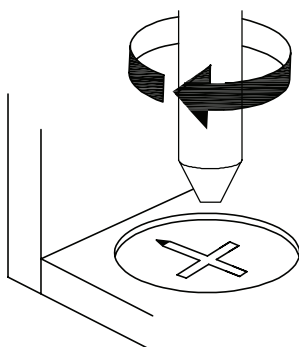

EN_Turn cam lock clockwise to tighten.

FR_Faites tourner la serrure batteuse dans le sens des aiguilles d'une montre pour la resserrer.

ES_Gire el cierre de la cámara en sentido horario para apretarlo.

DE_Drehen Sie den Cam-Lock im Uhrzeigersinn, um ihn festzuziehen.

IT_Ruotare il bloccaggio a camma in senso orario per stringere.

EN It may be necessary to adjust the hinges so that the doors align. Use the instructions below as a guide.

FR Il est parfois nécessaire d'ajuster les charnières pour un meilleur alignement des portes. Servez-vous des instructions ci-dessous comme guide.

ES Puede que sea necesario ajustar los quicios de forma que se alineen las puertas. Use las instrucciones que aparecen debajo como guía.

DE Möglicherweise müssen Sie die Scharniere so einstellen, dass die Türen ausgerichtet sind. Verwenden Sie die nachstehenden Anweisungen als Leitfaden.

IT Potrebbe essere necessario regolare le cerniere in modo che le porte siano allineate. Per fare ciò attenersi alle istruzioni sottostanti.

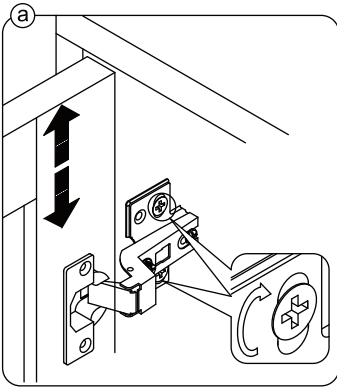

EN To adjust the door vertically loosen the screw as shown and move up and down as needed.

FR Si vous souhaitez régler la porte **verticalement**, desserrez la vis comme indiqué et déplacez la porte de haut en bas selon les besoins.

ES Para ajustar la puerta **verticalmente** afloje el tornillo tal y como se muestra y muévelo hacia arriba o hacia abajo según sea necesario.

DE Um die Tür **vertikal** auszurichten, lösen Sie die Schraube wie abgebildet und bewegen Sie sie nach Bedarf nach oben oder nach unten.

IT Per allineare la porta **verticalmente** allentare la vite come mostrato e spostarla in alto o in basso secondo necessità.

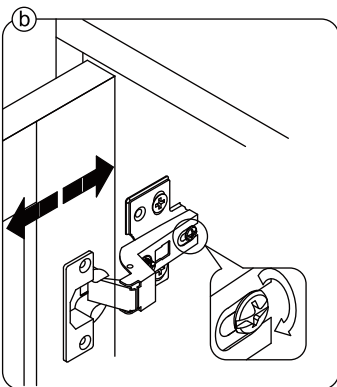

EN To adjust the gap from the door to the main frame turn the screw clockwise or anti-clockwise as needed.

FR Si vous souhaitez ajuster l'**écart** entre la porte et le cadre principal, tournez la vis dans le sens des aiguilles d'une montre ou dans le sens inverse, si nécessaire.

ES Para ajustar el **espacio** desde la puerta al marco principal, gire el tornillo en sentido horario o antihorario, según se necesite.

DE Um den **Abstand** von der Tür zum Hauptrahmen auszurichten, drehen Sie die Schraube je nach Bedarf im oder gegen den Uhrzeigersinn.

IT Per regolare lo **spazio** tra la porta e il telaio principale, avvitare o svitare la vite secondo necessità.

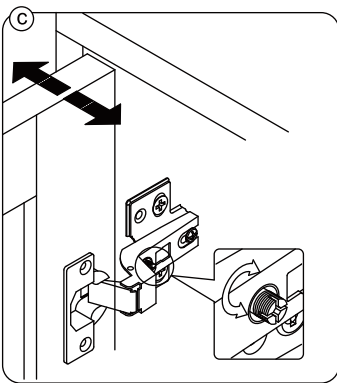

EN To adjust the door laterally adjust the screw as shown by turning clockwise or anti-clockwise.

FR Si vous souhaitez ajuster la porte **latéralement**, ajustez la vis comme indiqué en tournant dans le sens des aiguilles d'une montre ou dans le sens inverse des aiguilles d'une montre.

ES Para ajustar la puerta **lateralmente** ajuste el tornillo tal y como se muestra girándolo en sentido horario y antihorario.

DE Um die Tür **seitlich** auszurichten, stellen Sie bitte die Schraube wie abgebildet durch Drehen im oder gegen den Uhrzeigersinn ein.

IT Per allineare la porta **lateralmente** regolare la vite come mostrato, avvitarandola o svitarandola.

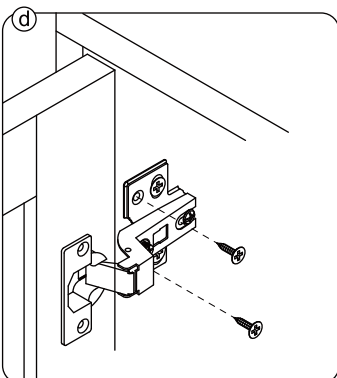

EN Please fix other screws



FR Merci de serrer les autres vis.

ES Fije los demás tornillos

DE Befestigen Sie bitte die anderen Schrauben



IT Fissare le altre viti

1

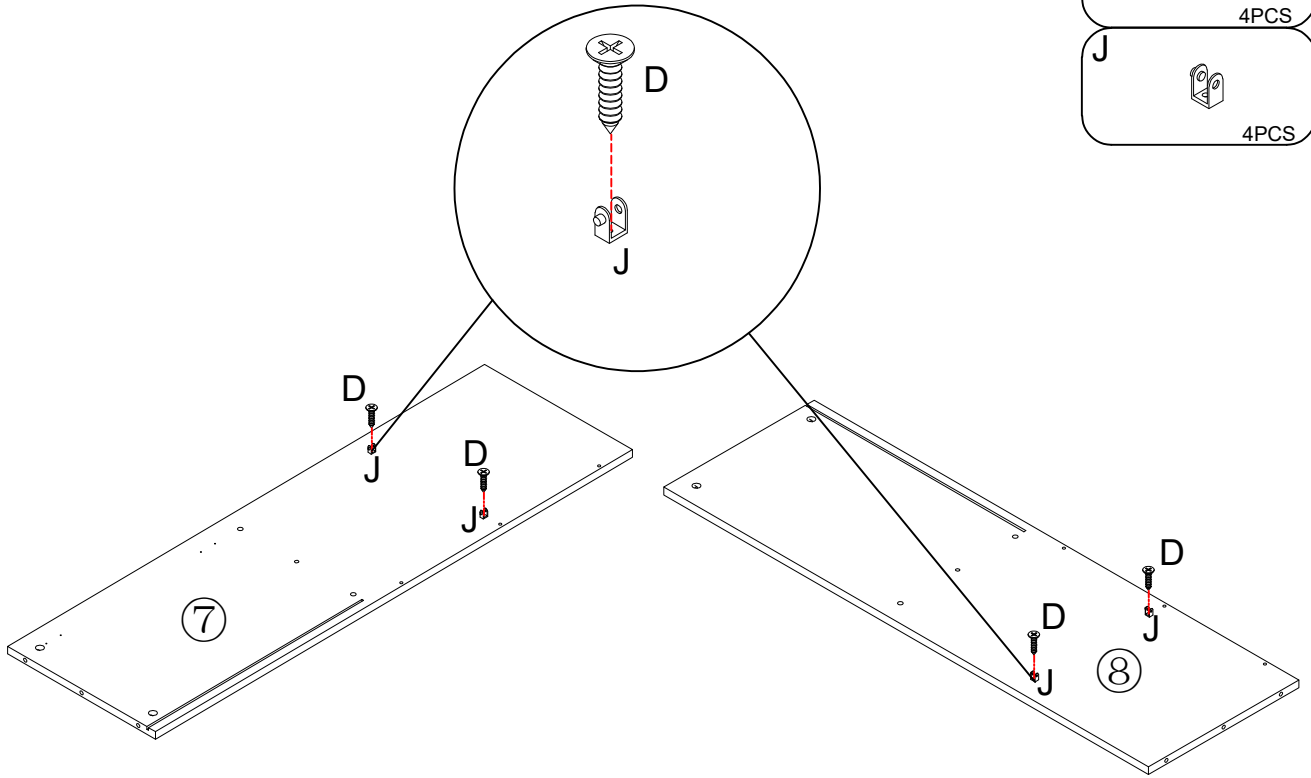
D	3.5*14
	
	4PCS
J	
	
	4PCS







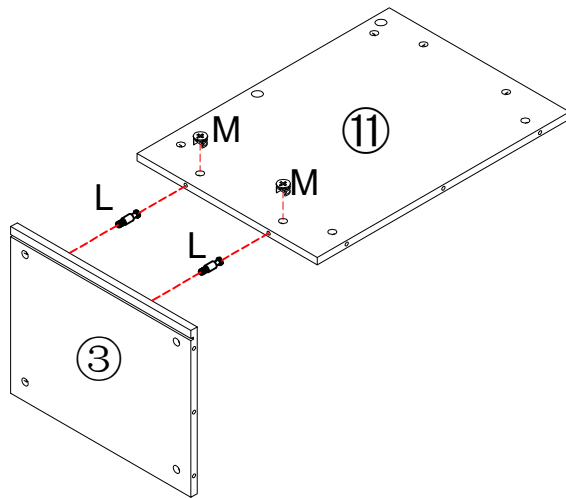

2

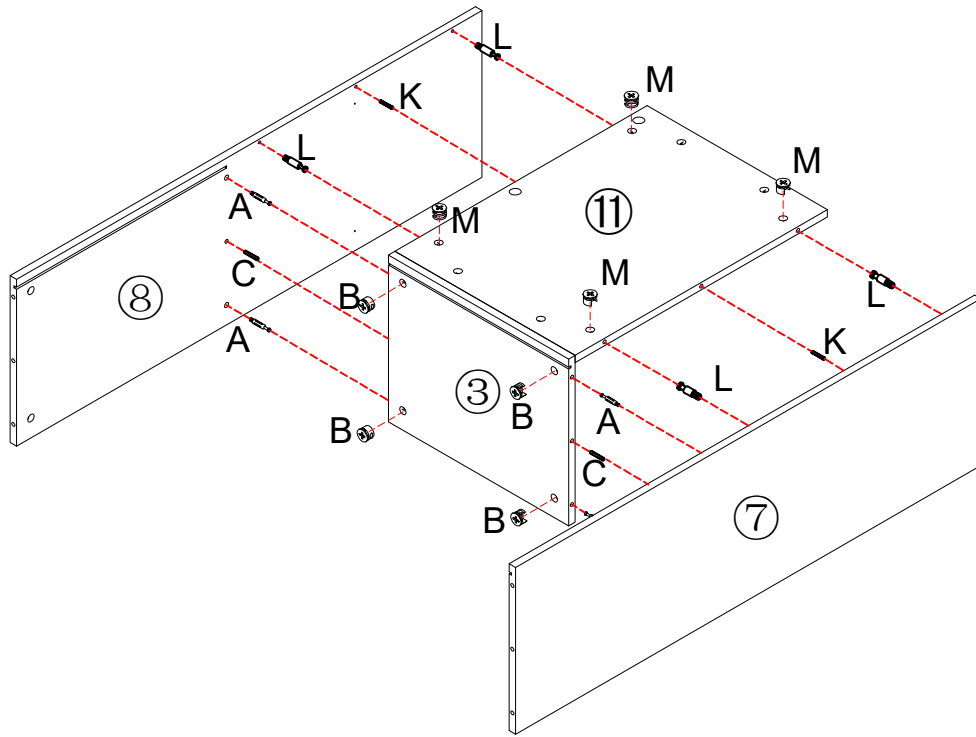
L	
	
	2PCS
M	
	
	2PCS

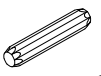

3





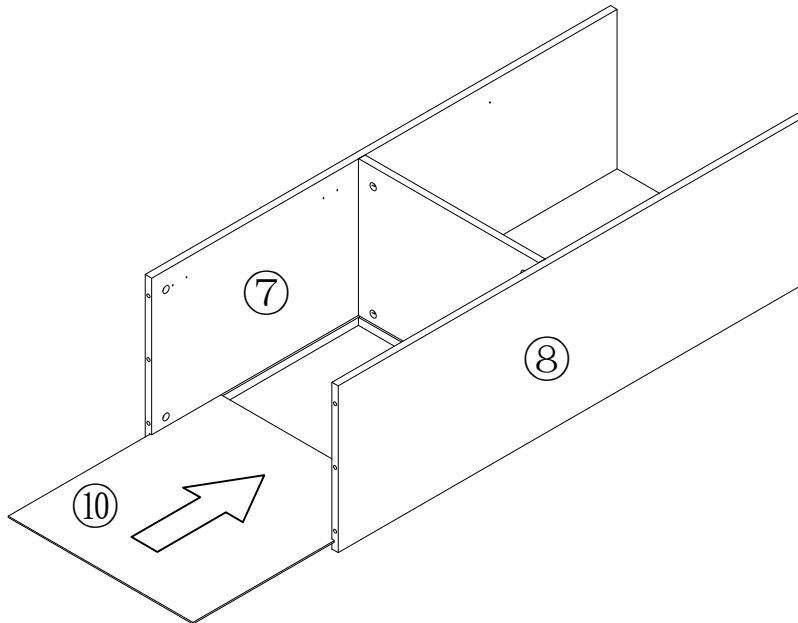

- A  4PCS
- B  4PCS
8*40
- C  2PCS
- K  2PCS
6*30
- L  4PCS
- M  4PCS

4

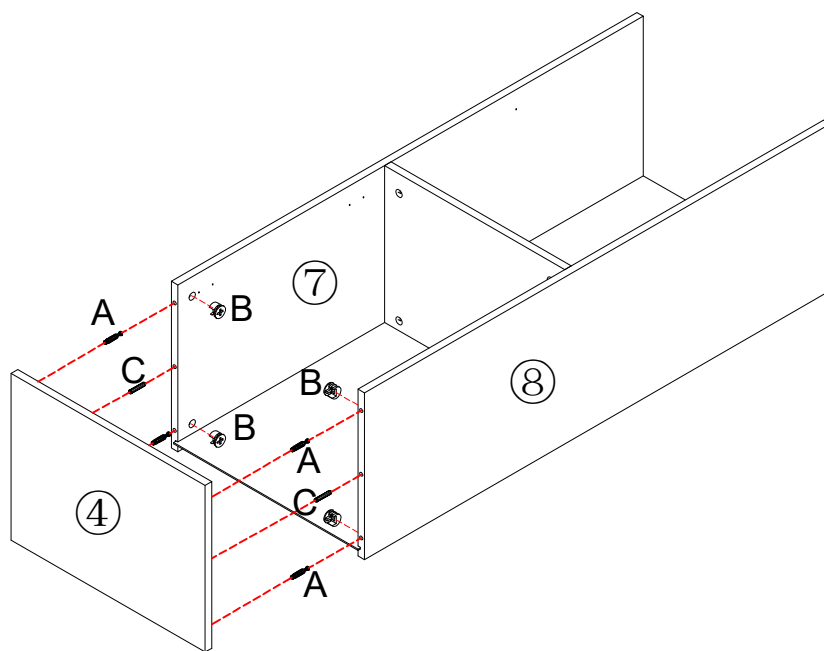





5

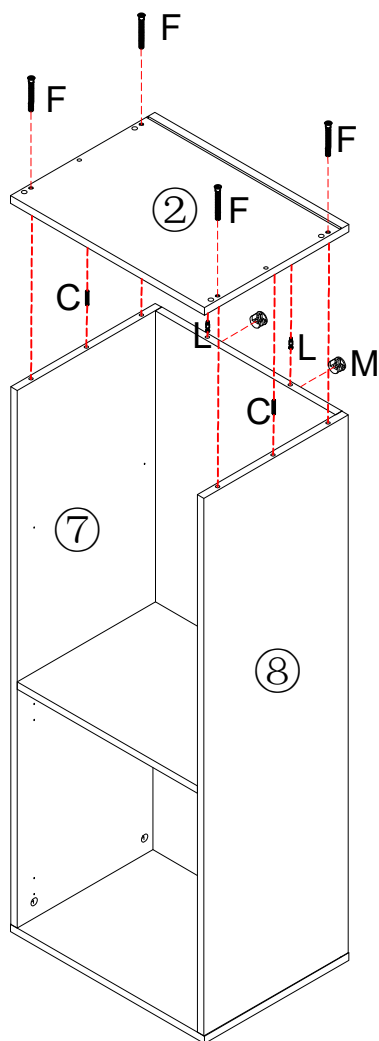

- A  4PCS
- B  4PCS
8*40
- C  2PCS



6



- F  7*50
4PCS
- L  2PCS
- M  2PCS
8*40
- C  2PCS

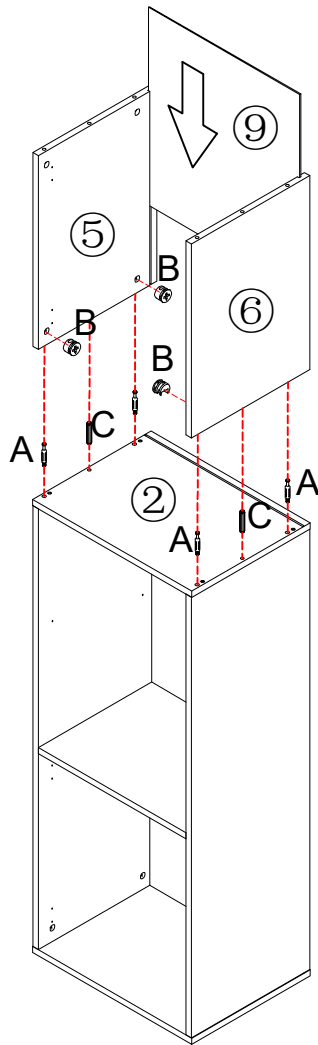

7

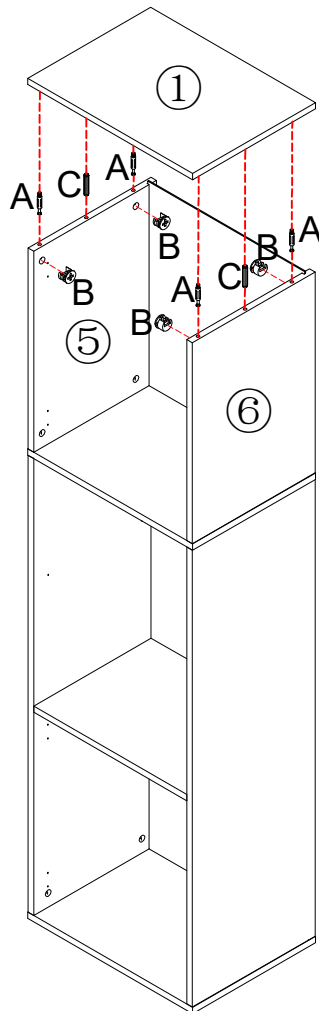

- A  4PCS
- B  4PCS
8*40
- C  2PCS

8



- A  4PCS
- B  4PCS
8*40
- C  2PCS

9

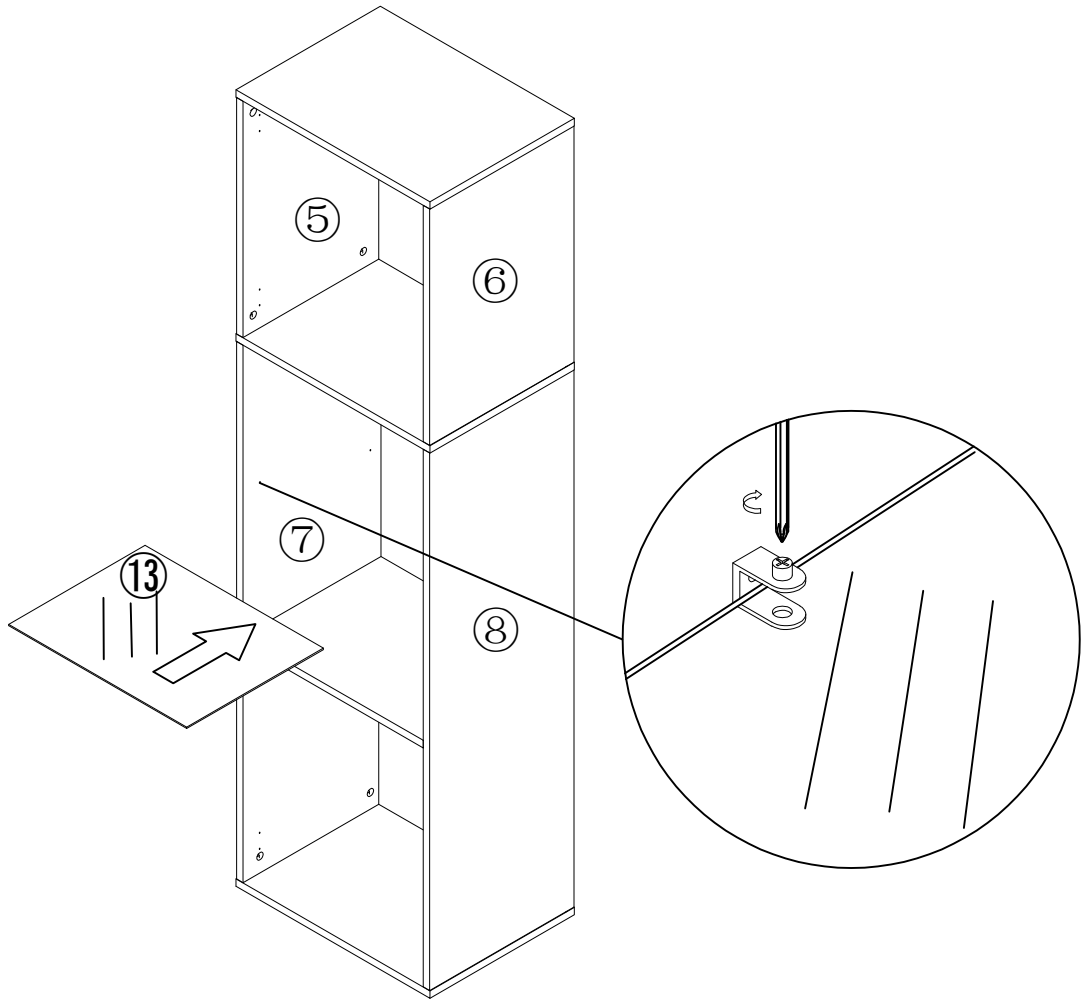

10

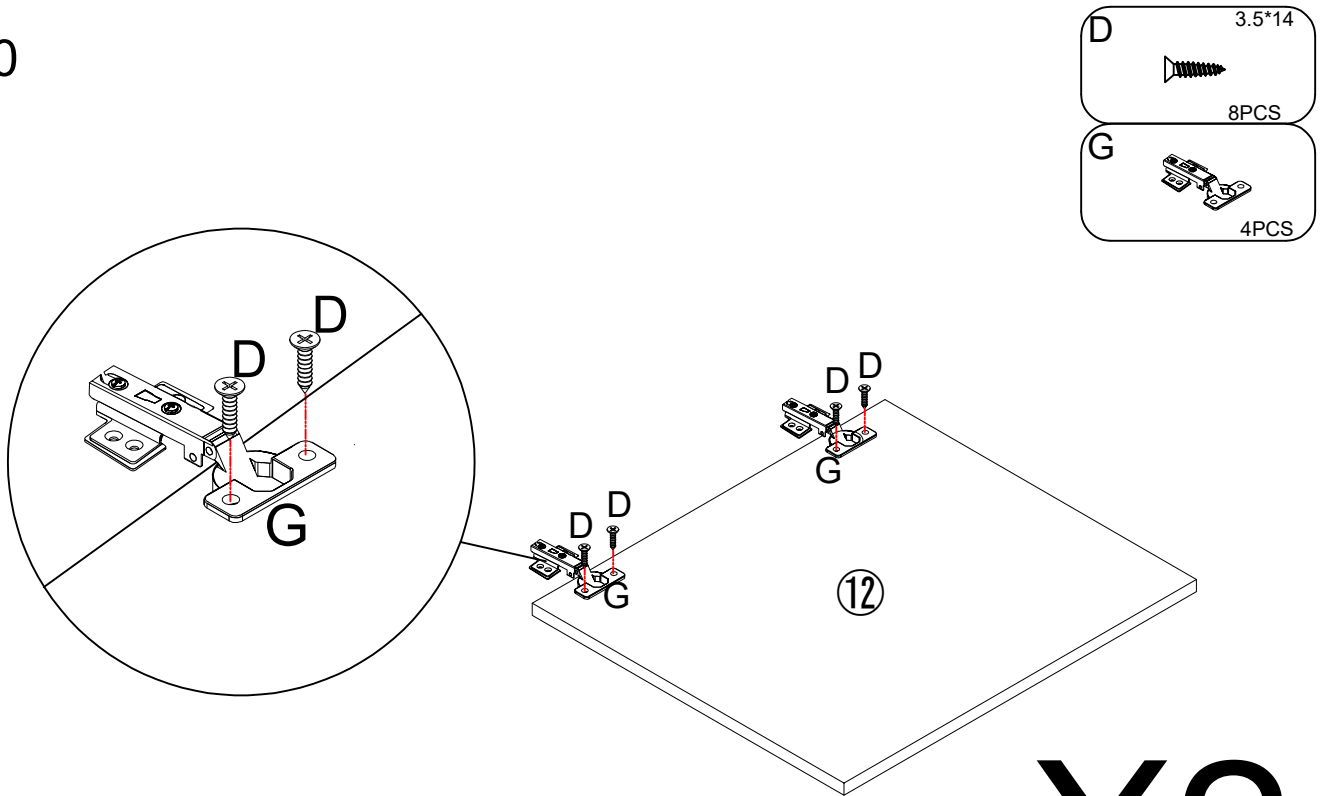

X2

11

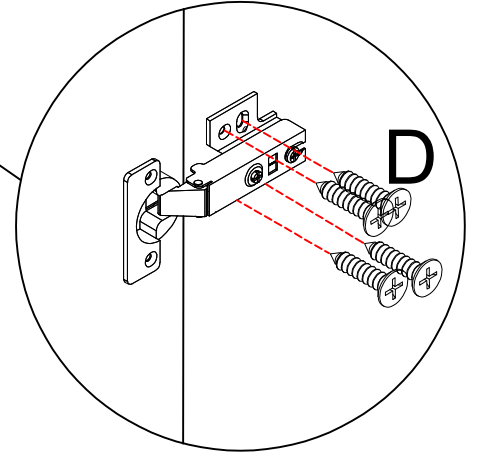
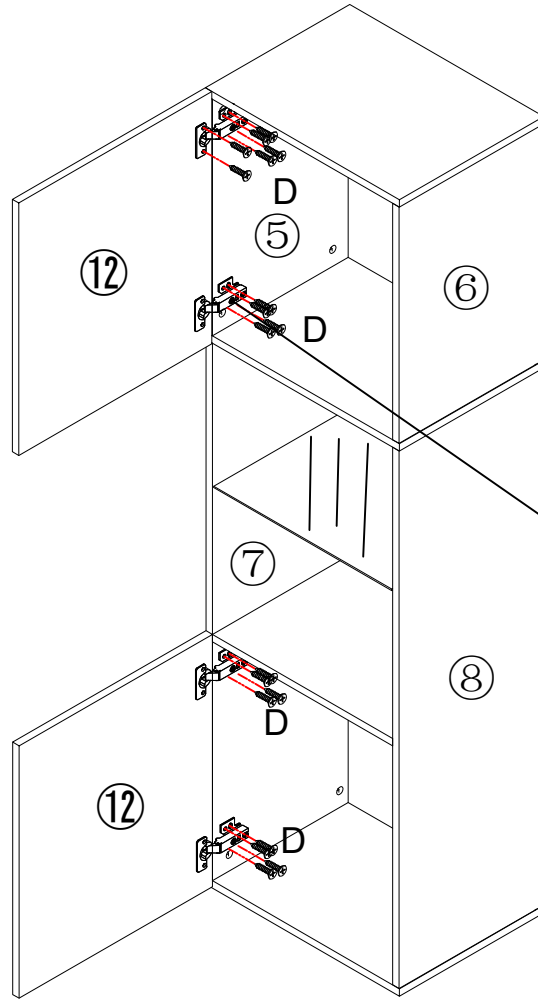
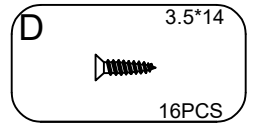

12

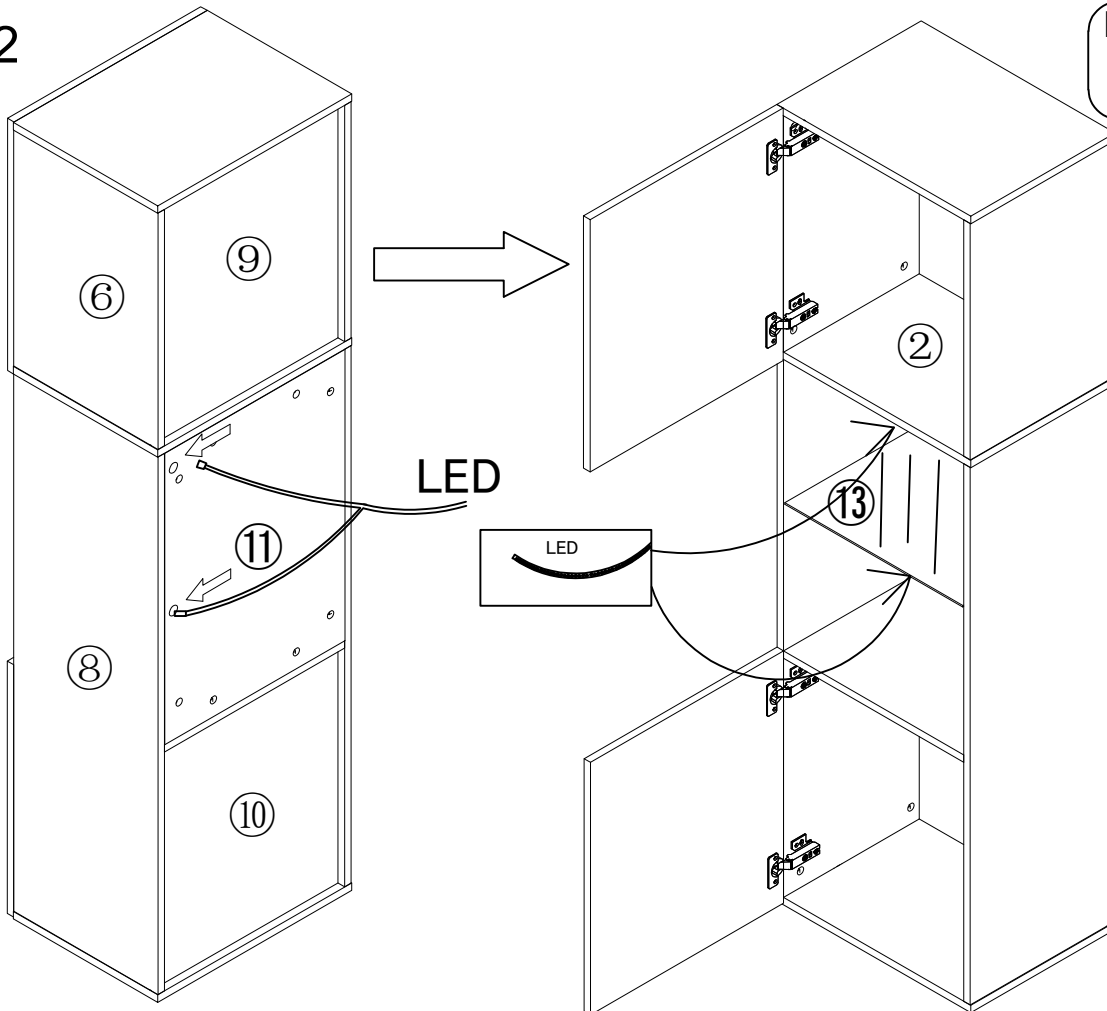
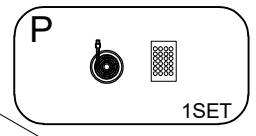

13

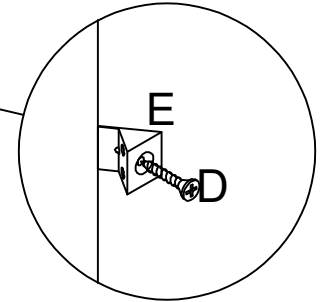
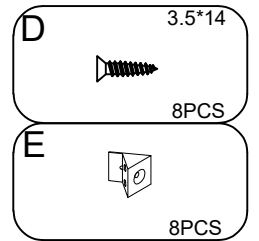
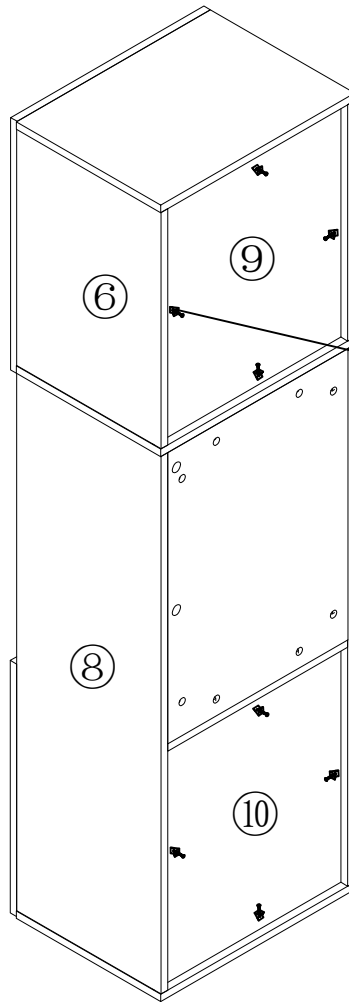

14

Wall
Wand
Parete
Mur
Pared

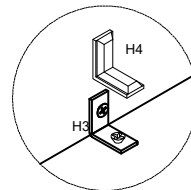
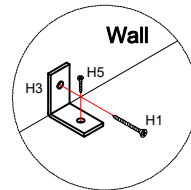
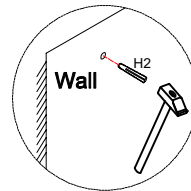
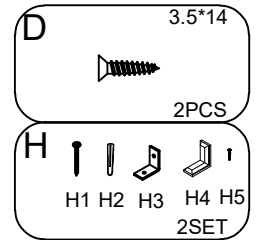
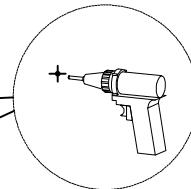
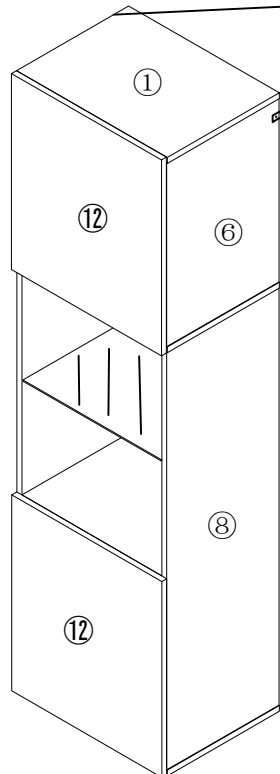

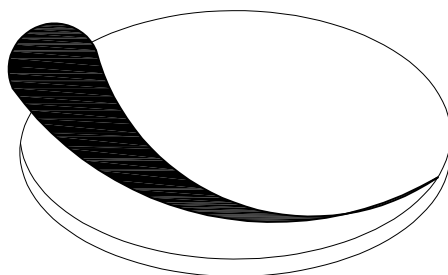

[DE]

BITTE BEACHTEN: Teilenummer 12 ist mit einer dichten Kunststoffschutzfolie überzogen. Wenn das Produkt nach der Demontage Kratzer aufweist, machen Sie sich bitte keine Sorgen, es handelt sich nicht um einen Produktschaden. Bitte ziehen Sie die schützende Kunststoffolie langsam entlang der Kante von der Oberfläche ab. Nach dem Abziehen wird das Produkt glatt und sauber.

[EN]

PLEASE NOTE: Part number 12 are covered with a tight plastic protective film. If there are scratches on the product after disassembly, please don't worry, it's not product damage. Please slowly tear off the protective plastic film on the surface along the edge. After peeling off, the product becomes smooth and clean.

[FR]

REMARQUE: les pièces numéro 12 sont recouvertes d'un film protecteur en plastique étanche. Si le produit présente des rayures après le démontage, ne vous inquiétez pas, il ne s'agit pas d'un dommage au produit. Retirez lentement le film protecteur en plastique sur la surface le long du bord. Une fois décollé, le produit devient lisse et propre.

[IT]

NOTA BENE: il numero di parte 12 è coperto da una pellicola protettiva in plastica stretta. Se ci sono graffi sul prodotto dopo lo smontaggio, non preoccuparti, non è un danno al prodotto. Strappare lentamente la pellicola protettiva in plastica sulla superficie lungo il bordo. Dopo averla staccata, il prodotto diventa liscio e pulito.

[ES]

NOTA: La pieza número 12 está cubierta con una película protectora de plástico. Si hay rayones en el producto después de desmontarlo, no se preocupe, no se trata de daños en el producto. Retire lentamente la película protectora de plástico de la superficie a lo largo del borde. Después de despegarla, el producto quedará liso y limpio.

[DE]

HINWEIS: Der Akku in der Fernbedienung erfordert, dass Sie Sie selbst kaufen und installieren.

Modell: CR2025 3.V

[EN]

NOTE: The battery in the remote control requires you to purchase and install it yourself.

Model: CR2025 3.V

[FR]

REMARQUE : La pile de la télécommande est requise. que vous les achetez et les installez vous-même.

Modèle : CR2025 3.V

[IT]

NOTA: la batteria del telecomando richiede. che li acquisti e li installi tu stesso.

Modello: CR2025 3.V

[ES]

NOTA: La batería del control remoto requiere. que los compre e instale usted mismo.

Modelo: CR2025 3.V



Modell : CR2025 3.V



Verification of Compliance

Verification No.: TMC210319126-E
Name and address of Applicant: Shenzhen CWG Technology Co., Ltd
 5 / F, No.264 Baoshi East Road, Shiyan street, Bao'an District, Shenzhen,China 518108
Name and address of Manufacturer: Shenzhen CWG Technology Co., Ltd
 5 / F, No.264 Baoshi East Road, Shiyan street, Bao'an District, Shenzhen,China 518108
Product name: LED Strip
Rated: DC12V
Product model(s): CWG-5050RGB-60D-12V , additional models reference attachment
Product trademark: 创唯光

This verification confirms that the product meets the requirements of the following standard.
 The conformity was demonstrated based on following standard(s) listed by European Commission as harmonized with EMC Directive 2014/30/EU.

EN IEC 55015:2019+A11:2020
 IEC 61547:2020

The verification has been carried out in accordance with individual rules and conditions agreed with the applicant. Evaluation has been carried out in accordance with:

Test report(s) No.: TMC210319126-E
Test conducted by: TMC Testing Services (Shenzhen) Co., Ltd.
Verification issue date: March 26, 2021

Notes:

This verification refers to the above mentioned product and its conformity in regards of above mentioned standard(s) was proven on test sample.

This verification does not imply meeting all essential requirements, assessment of the series-production or any other restricted Notified Bodies conformity assessment procedure appropriate for the product.

This verification holder shall use this verification in connection to verification of conformity and technical data relevant for the product the verification was issued.

TMC Testing Services (Shenzhen) Co., Ltd.

t:86-755-86642861 cert@tmc-lab.com www.tmc-lab.com

1st Floor, Block A1, Zone A, Xinshidai Gongrong Industrial Park, No. 2, Shihuan Road, Shiyan Street, Baoan District, Shenzhen, China



Verification of Compliance

CWG-5050RGB-30D-12V, CWG-5050RGB-18D-12V, CWG-5050RGB-60D-24V,
CWG-5050RGB-60D-5V, CWG-5050RGB-30D-5V, CWG-5050RGB-18D-5V,
CWG-5050-60D-12V, CWG-5050-30D-12V, CWG-5050-60D-24V,
CWG-HC5050RGB-60D-12V, CWG-HC5050RGB-30D-12V,
CWG-HC5050RGB-60D-24V, CWG-HC5050-60D-12V, CWG-HC5050-30D-12V,
CWG-HC5050-60D-24V, CWG-HC5050RGB-30D-5V, CWG-HC5050RGB-60D-5V,
CWG-HC5050RGB-144D-5V, CWG-2835-60D-12V, CWG-2835-120D-12V,
CWG-2835-60D-24V, CWG-2835-120D-24V, CWG-2835-60D-5V, CWG-2835-120D-5V

Note:

This attachment only valided with Verification No.: TMC210319126-E