

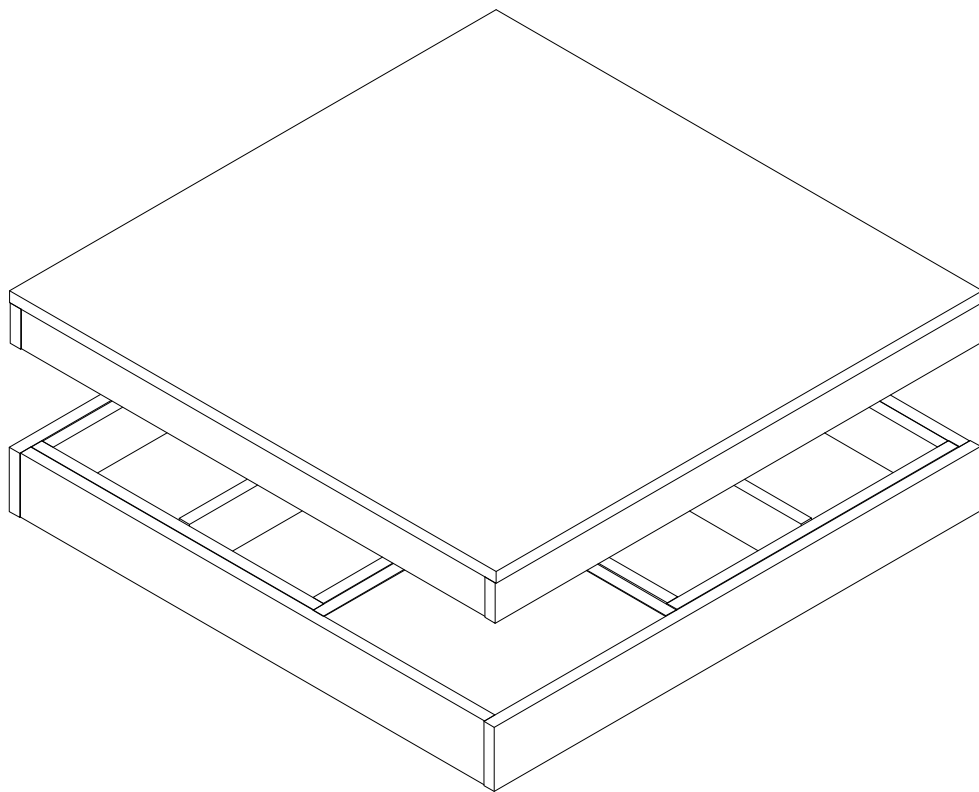





# N625P233246

Product manual  
Gebrauchsanweisung  
Manuel du produit  
Manual del producto  
Manuale del prodotto

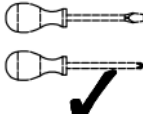

 2PERS	 45 MIN	Tool Required Not Provided	
			 
			



[DE]

**Warnung:** Lesen Sie die Anleitung vor dem Zusammenbau bitte vollständig durch. Überprüfen Sie, ob Sie alle auf den Seiten aufgeführten Komponenten und Werkzeuge haben.

**Warnung:** Legen Sie alle Teile auf eine ebene Fläche. Legen Sie eine weiche Decke oder Ähnliches darunter, um sie vor Kratzern oder Flecken zu schützen. Vermeiden Sie es, Komponenten über den Boden zu ziehen oder zu schieben.

**Warnung:** Überprüfen Sie regelmäßig alle Beschläge und Befestigungen, um sicherzustellen, dass sie sicher sind und um Unfälle zu vermeiden. Wenn Teile fehlen, kaputt, beschädigt oder abgenutzt sind, verwenden Sie das Produkt nicht weiter, bis es mit vom Hersteller autorisierten Teilen repariert wurde.

**Warnung:** Lassen Sie Kinder nicht auf die Möbel klettern, da dies zum Umkippen und zu schweren Verletzungen führen kann. Bauen Sie die Möbel außerhalb der Reichweite von Kindern zusammen.

**Warnung:** Stellen Sie die Möbel nicht in die Nähe von Feuerquellen oder heißen Gegenständen, um Brandgefahr zu vermeiden.

**Warnung:** Reinigen Sie die Möbel mit einem feuchten Tuch oder Alkohol. Verwenden Sie keine Reinigungsmittel mit ätzenden Chemikalien.

[EN]

**Warning:** Please read instructions fully before starting assembly. Check you have all the components and tools listed on pages.

**Warning:** Please place all parts on a flat surface. Place a soft blanket or similar underneath to protect against scratches or stains. Avoid dragging or sliding components across the floor.

**Warning:** Regularly check all fittings and fastenings to ensure they are secure and to prevent accidents. If any parts are missing, broken, damaged, or worn, discontinue use of the product until repairs have been made using factory authorized parts.

**Warning:** Do not allow children to climb on the furniture as this may result in tipping and serious personal injury. Assemble the furniture away from the reach of children.

**Warning:** Do not place furniture close to fire sources or high-temperature objects to avoid the risk of fire.

**Warning:** Clean furniture with a damp cloth or alcohol, avoid using cleaning agents containing corrosive chemicals.

[FR]

**Avertissement :** Veuillez lire entièrement les instructions avant de commencer l'assemblage. Vérifiez que vous disposez de tous les composants et outils répertoriés sur les pages.

**Avertissement :** Veuillez placer toutes les pièces sur une surface plane. Placez une couverture douce ou similaire en dessous pour les protéger des rayures ou des taches. Évitez de faire glisser les composants sur le sol.

**Avertissement :** Vérifiez régulièrement tous les raccords et fixations pour vous assurer qu'ils sont bien fixés et pour éviter les accidents. Si des pièces manquent, sont cassées, endommagées ou usées, cessez d'utiliser le produit jusqu'à ce que des réparations aient été effectuées à l'aide de pièces autorisées par l'usine.

**Avertissement :** Ne laissez pas les enfants grimper sur les meubles car cela pourrait entraîner un basculement et des blessures graves. Assemblez les meubles hors de portée des enfants.

**Avertissement :** Ne placez pas les meubles à proximité de sources de feu ou d'objets à haute température pour éviter tout risque d'incendie.

**Avertissement :** Nettoyez les meubles avec un chiffon humide ou de l'alcool, évitez d'utiliser des produits de nettoyage contenant des produits chimiques corrosifs.



[IT]

**Attenzione:** leggere attentamente le istruzioni prima di iniziare il montaggio. Verificare di avere tutti i componenti e gli strumenti elencati nelle pagine.

**Attenzione:** posizionare tutte le parti su una superficie piana. Posizionare una coperta morbida o simile sotto per proteggere da graffi o macchie. Evitare di trascinare o far scivolare i componenti sul pavimento.

**Attenzione:** controllare regolarmente tutti i raccordi e i dispositivi di fissaggio per assicurarsi che siano sicuri e per prevenire incidenti. Se alcune parti sono mancanti, rotte, danneggiate o usurate, interrompere l'uso del prodotto fino a quando non siano state eseguite le riparazioni utilizzando parti autorizzate dalla fabbrica.

**Attenzione:** non consentire ai bambini di arrampicarsi sui mobili poiché ciò potrebbe causare ribaltamenti e gravi lesioni personali. Montare i mobili lontano dalla portata dei bambini.

**Attenzione:** non posizionare i mobili vicino a fonti di fuoco o oggetti ad alta temperatura per evitare il rischio di incendio.

**Attenzione:** pulire i mobili con un panno umido o alcol, evitare di utilizzare detergenti contenenti sostanze chimiche corrosive.

[ES]

**Advertencia:** Lea las instrucciones completamente antes de comenzar el montaje. Compruebe que tiene todos los componentes y herramientas que se enumeran en las páginas.

**Advertencia:** Coloque todas las piezas sobre una superficie plana. Coloque una manta suave o algo similar debajo para protegerlas de rayones o manchas. Evite arrastrar o deslizar los componentes por el piso.

**Advertencia:** Verifique regularmente todos los accesorios y fijaciones para asegurarse de que estén seguros y evitar accidentes. Si falta alguna pieza, está rota, dañada o desgastada, deje de usar el producto hasta que se hayan realizado las reparaciones con piezas autorizadas de fábrica.

**Advertencia:** No permita que los niños se suban a los muebles, ya que esto puede provocar que se vuelquen y lesiones personales graves. Monte los muebles fuera del alcance de los niños.

**Advertencia:** No coloque los muebles cerca de fuentes de fuego u objetos de alta temperatura para evitar el riesgo de incendio.

**Advertencia:** Limpie los muebles con un paño húmedo o alcohol, evite usar agentes de limpieza que contengan químicos corrosivos.

<b>Importeur</b>	Decobus Handel GmbH		
<b>Adresse</b>	Innungsstraße 9, 21244 Buchholz, Deutschland		
<b>URL</b>	<a href="https://www.decobusgroup.de">https://www.decobusgroup.de</a>		
<b>Hersteller</b>	SHANDONG YIJUMUZHAI SMART HOMECO.,LTD		
<b>Adresse</b>	1666MEASTOFJINGUANG STREETBRIDGE,LUOCHENG TOWN, SHOUGUANGCITY,WEIFANG CITY,SHANDONG PROVINCE		
<b>Email/URL</b>	<a href="http://www.yinjumuzhai.com">http://www.yinjumuzhai.com</a>		
<table border="1"><tr><td>EC</td><td>REP</td></tr></table>	EC	REP	Decobus Handel GmbH Innungsstraße 9, 21244 Buchholz, Deutschland <a href="https://www.decobusgroup.de">https://www.decobusgroup.de</a>
EC	REP		

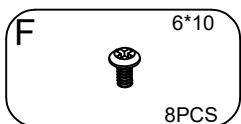
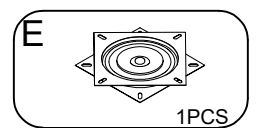
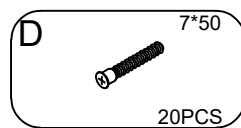
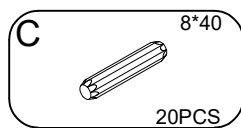
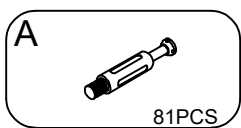
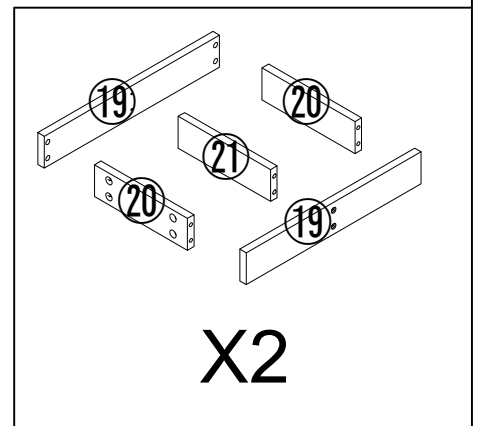
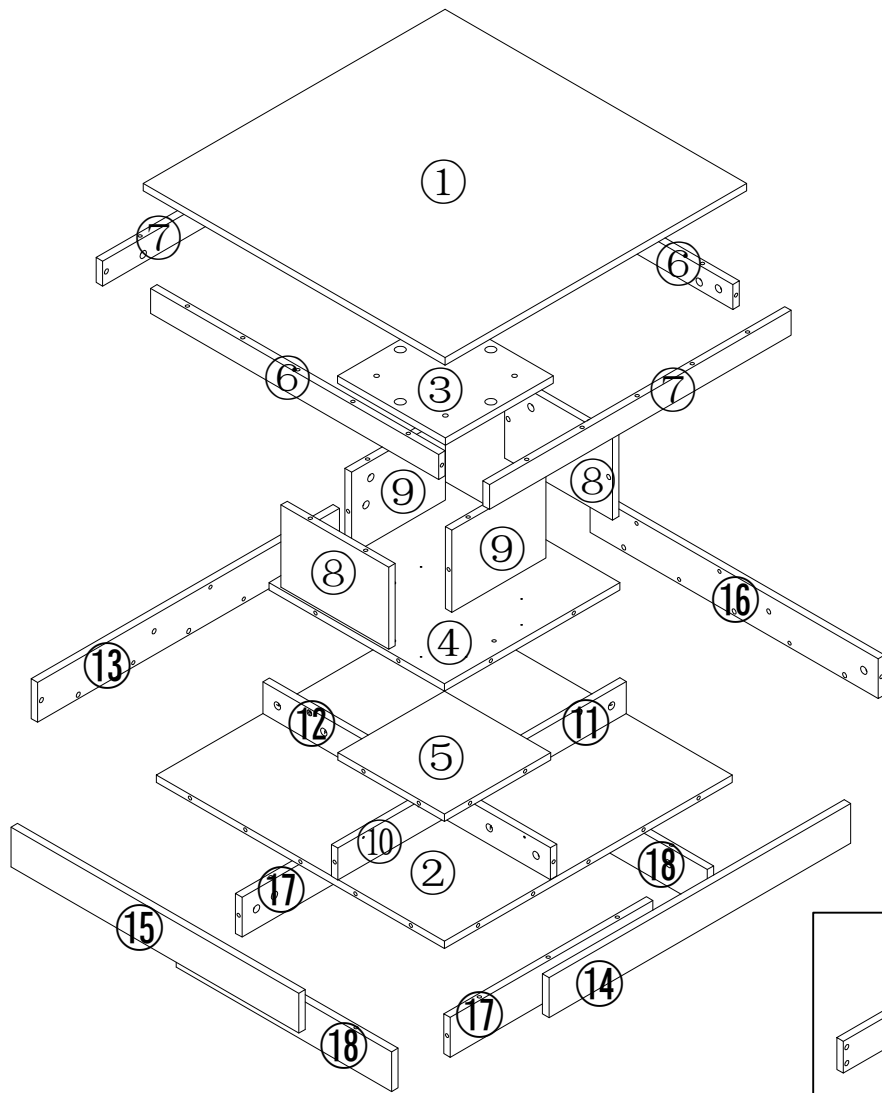

①X1

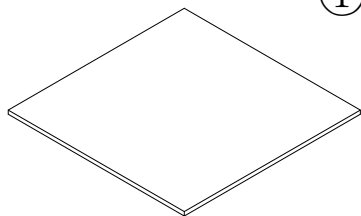

⑧X2

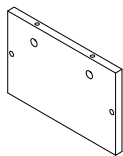

⑮X1

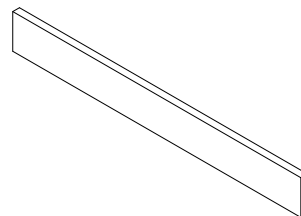

②X1

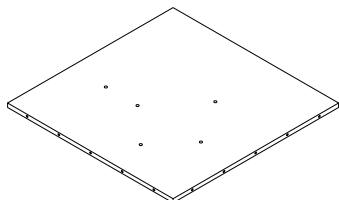

⑨X2

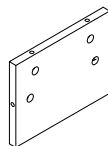

⑯X1

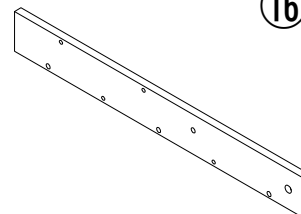

③X1

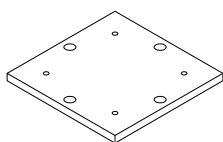

⑩X1

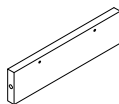

⑰X2

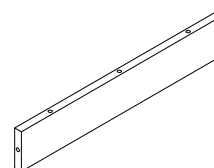

④X1

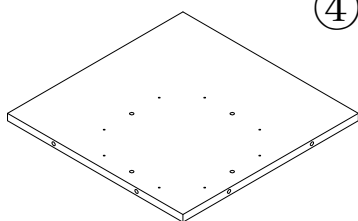

⑪X1

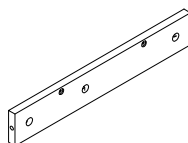

⑱X2

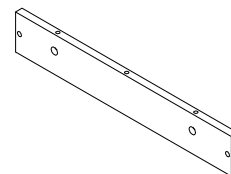

⑤X1

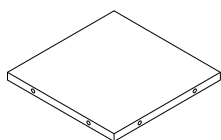

⑫X1

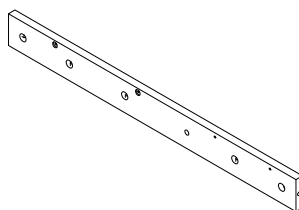

⑲X4

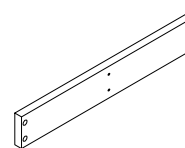

⑥X2

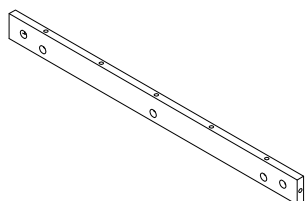

⑬X1

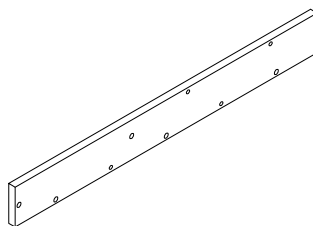

⑳X4

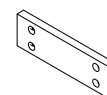

⑦X2

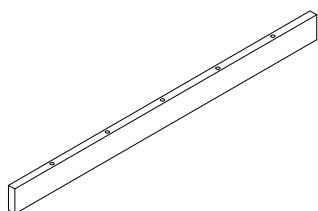

⑭X1

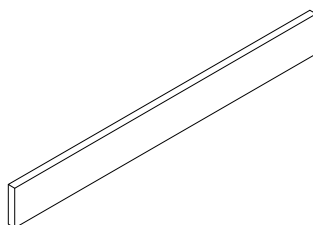

㉑X2

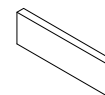

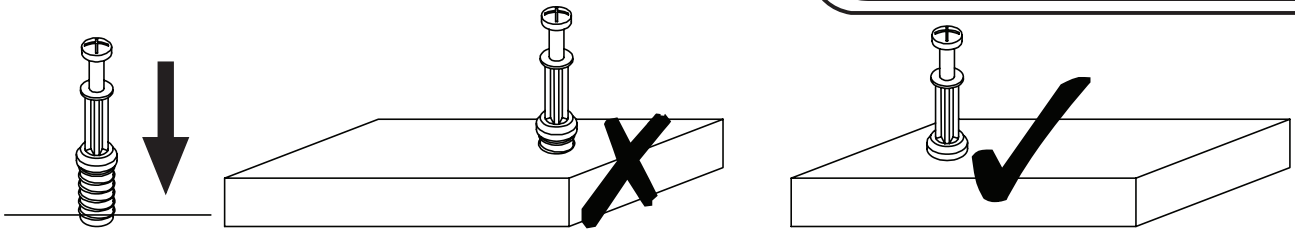

**EN\_QUICKFIT:** Tighten quickfit until shoulder is flush with panel. Do not overtighten or undertighten.

**FR\_RACCORD RAPIDE:** Faites serrer le raccord rapide jusqu'à ce que l'épaulement soit parfaitement encastré dans le panneau. Il ne faut ni trop serrer ni insuffisamment serrer.

**ES\_QUICKFIT:** Apriete quickfit hasta que el hombro se descargue con el panel. NO lo sobreapriete ni lo apriete poco.

**DE\_QUICKFIT:** Ziehen Sie den Quickfit fest, bis die Schulter mit der Platte bündig ist. Bitte nicht zu fest oder zu schwach anziehen.

**IT\_MONTAGGIO RAPIDO:** Stringere il montaggio rapido fino a quando la spalla è a filo con il pannello, non stringere troppo o troppo poco.

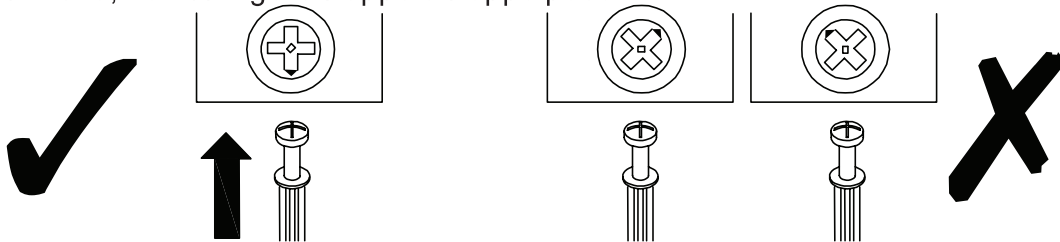

**EN\_CAM LOCK:** When fitting cam lock, ensure starting position is correct before you insert connecting quickfit.

**FR\_SERRURE BATTEUSE:** Avant d'insérer la serrure batteuse, veillez à la bonne orientation avant d'insérer le raccord rapide.

**ES\_CIERRE DE LA CÁMARA:** Cuando instale el cierre de la cámara, asegúrese de que la posición de inicio es correcta antes de que inserte el quickfit conector.

**DE\_CAM-LOCK:** Achten Sie bei der Montage des Cam-Locks auf die richtige Ausgangsposition, bevor Sie den Quickfit einsetzen.

**IT\_BLOCCAGGIO A CAMMA:** Quando si monta il bloccaggio a camma, assicurarsi che la posizione iniziale sia corretta prima di inserire il montaggio rapido di collegamento.

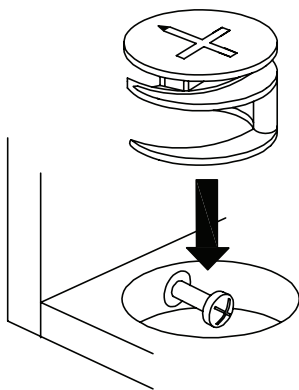

**EN\_Quickfit head** should be in the centre of the cam lock when the two panels are joined.

Cam lock should be inserted before quickfit.

**FR\_**Lorsque les deux panneaux sont assemblés, la tête du raccord rapide doit reposer au centre de la serrure batteuse. Il faut insérer la serrure batteuse avant le raccord rapide.

**ES\_**El cabezal del quickfit debe estar en el centro del cierre de la cámara cuando se unan los dos paneles.

Se debe insertar el cierre de la cámara antes que el quickfit.

**DE\_**Der Quickfit-Kopf sollte sich in der Mitte des Cam-Locks befinden, wenn die beiden Platten zusammengefügt sind. Der Cam-Lock sollte vor dem Quickfit eingesetzt werden.

**IT\_**La testa del montaggio rapido deve trovarsi al centro del bloccaggio a camma quando i due pannelli sono uniti.

Il Bloccaggio a Camma deve essere inserito prima del montaggio rapido.

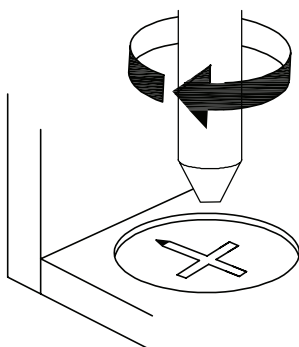

**EN\_**Turn cam lock clockwise to tighten.

**FR\_**Faites tourner la serrure batteuse dans le sens des aiguilles d'une montre pour la resserrer.

**ES\_**Gire el cierre de la cámara en sentido horario para apretarlo.

**DE\_**Drehen Sie den Cam-Lock im Uhrzeigersinn, um ihn festzuziehen.

**IT\_**Ruotare il bloccaggio a camma in senso orario per stringere.

1

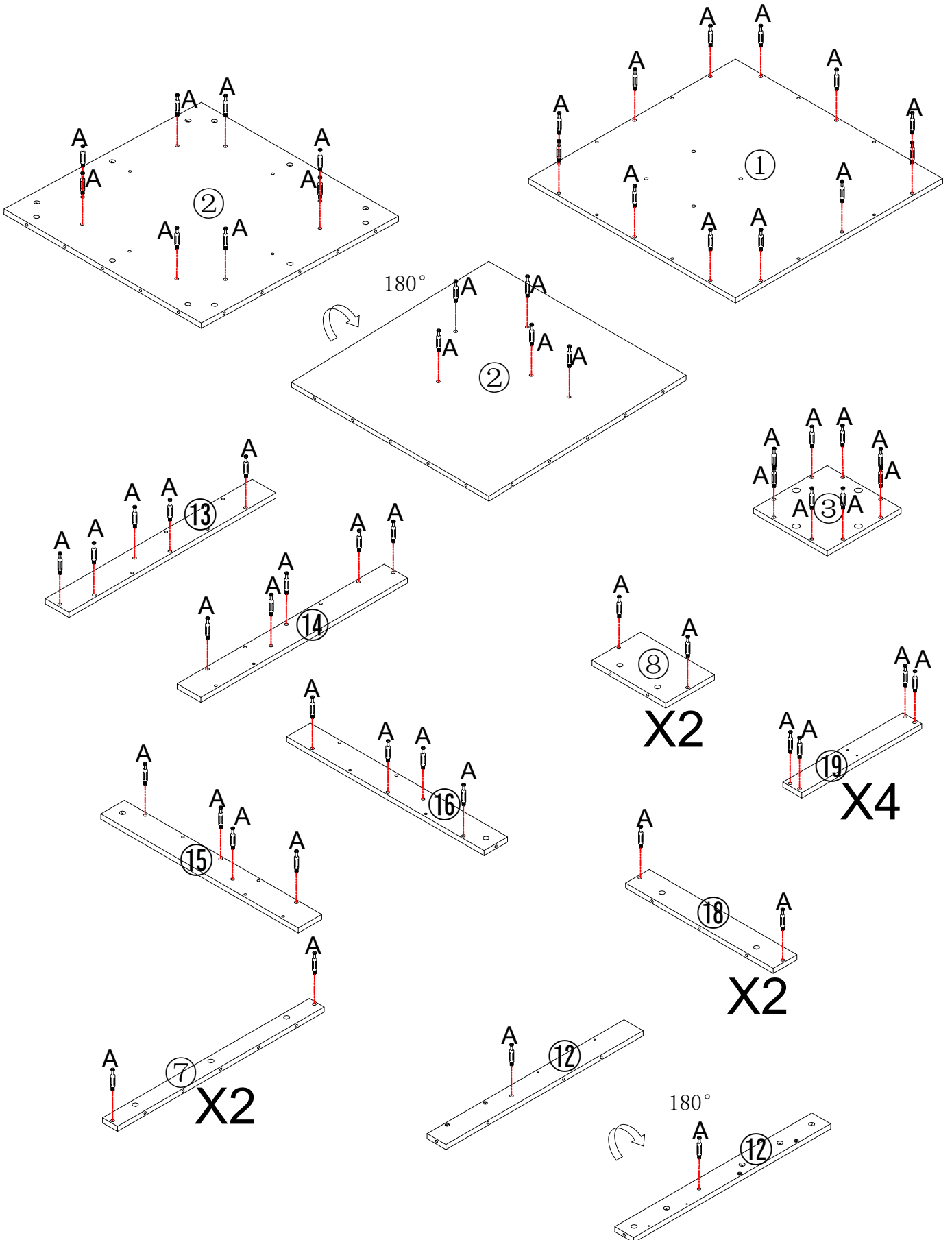
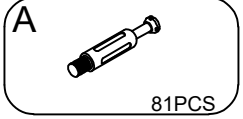
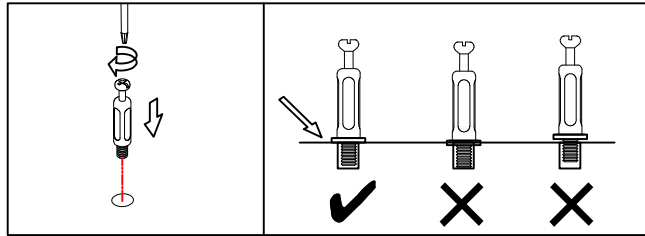

2

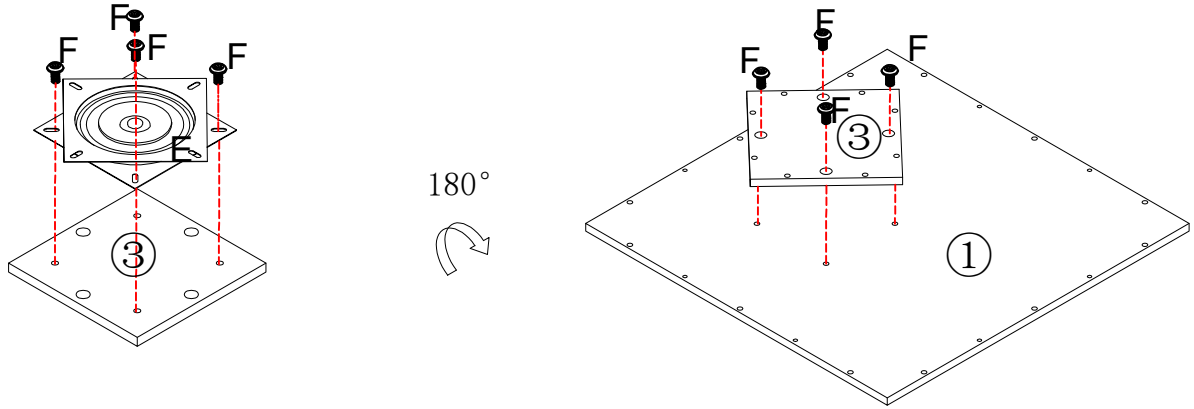
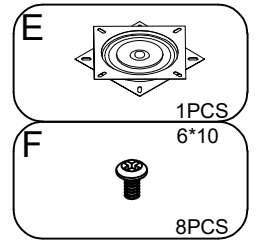

3

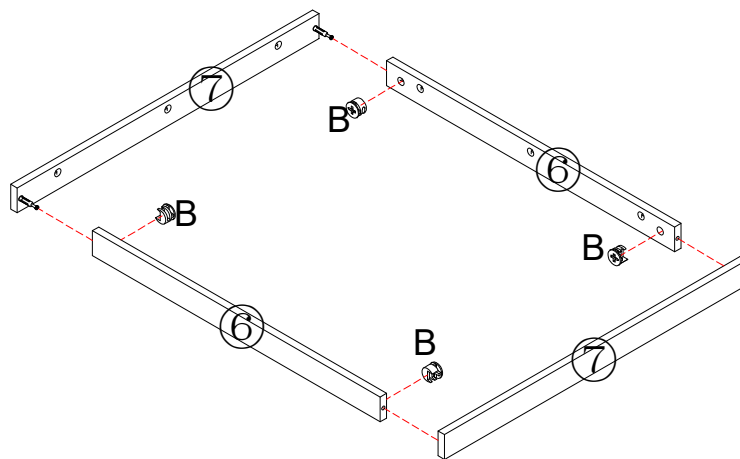

4

**B**  12PCS  
8\*40

**C**  8PCS

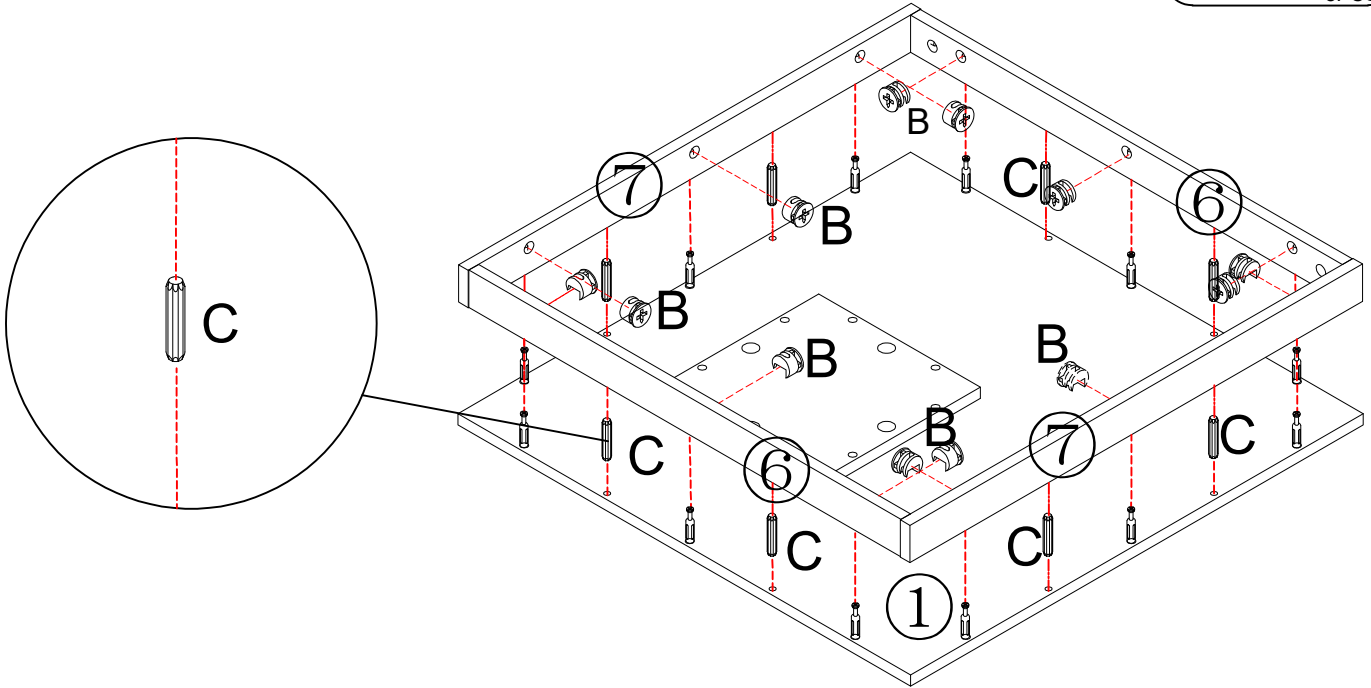

5

**B**  4PCS

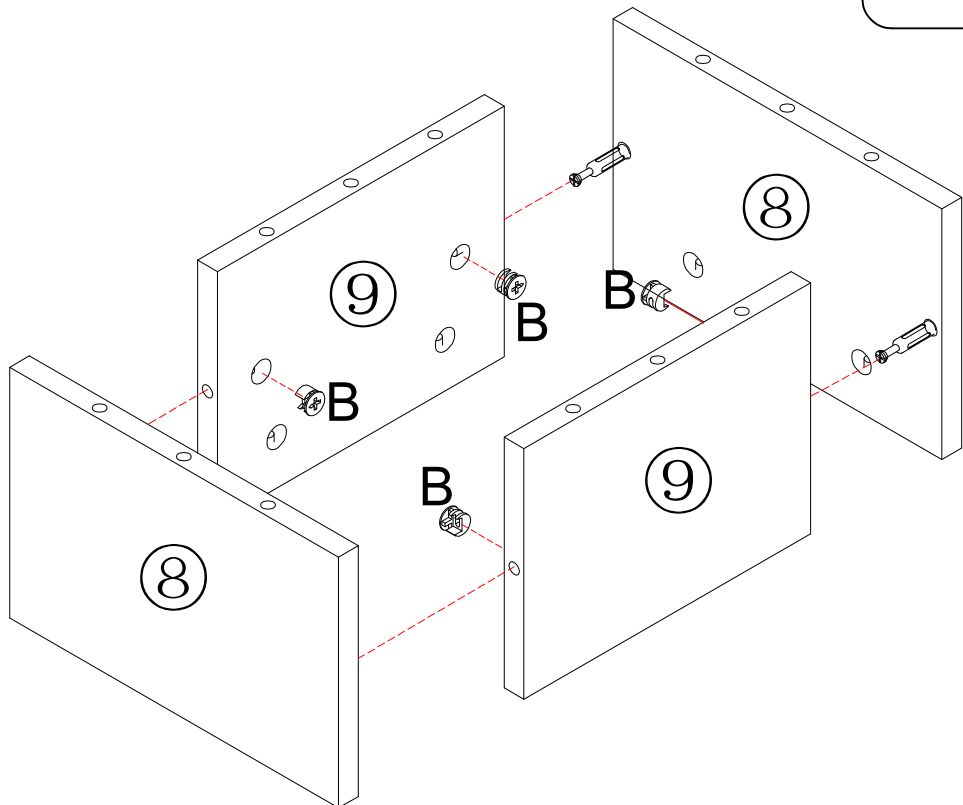

6

**B**  8PCS

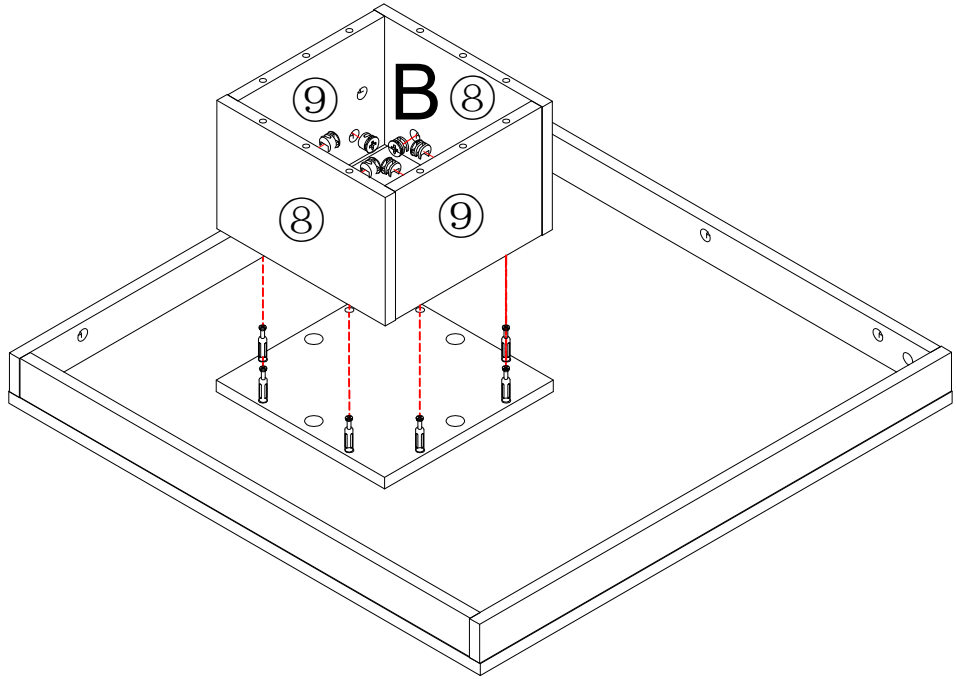

7

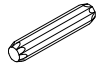
**C**  8\*40  
4PCS

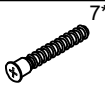
**D**  7\*50  
8PCS

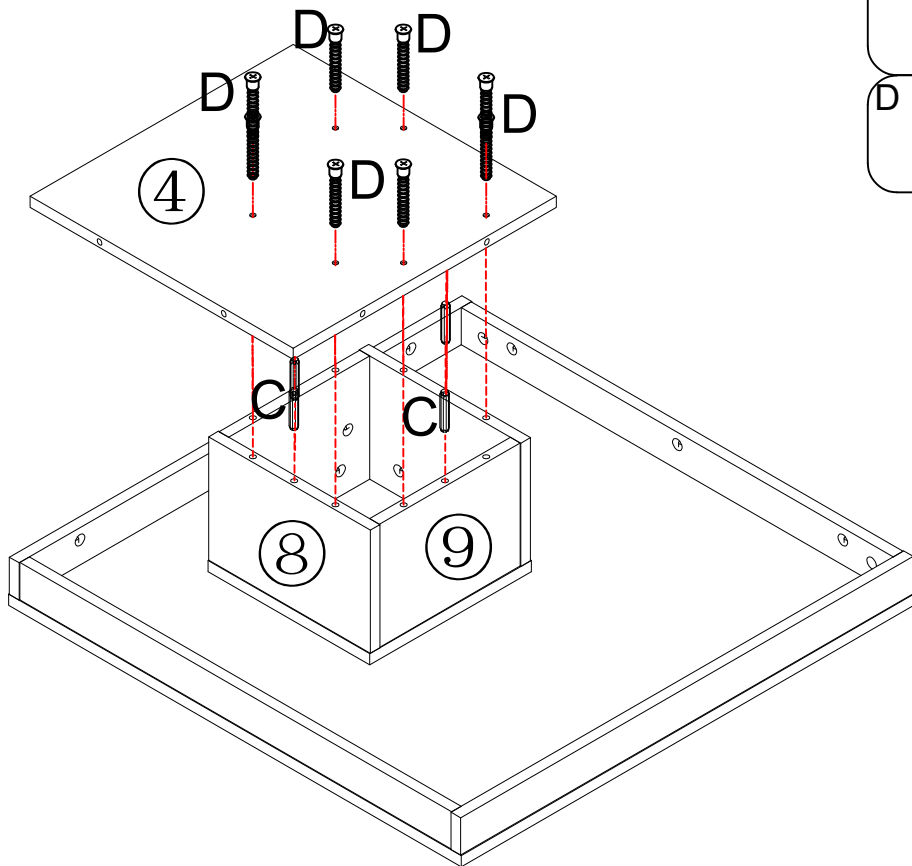

8

**B**  4PCS

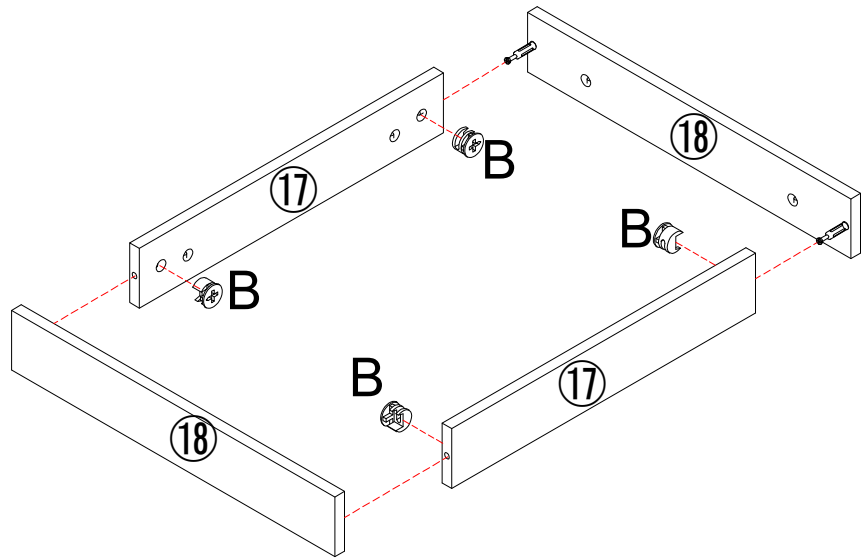

9

**B**  8PCS  
8\*40

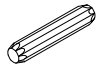
**C**  4PCS

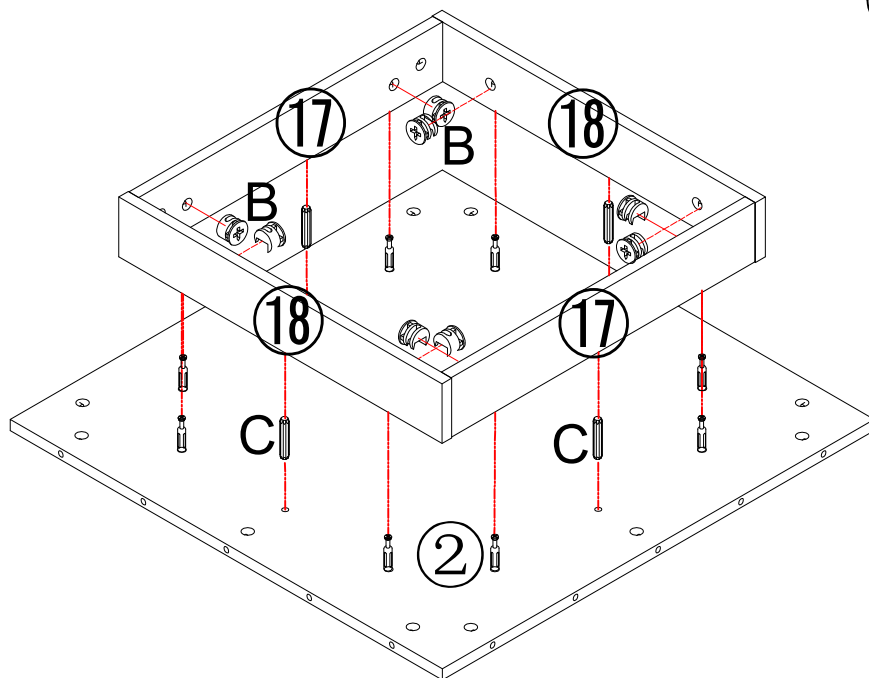

10

B  2PCS

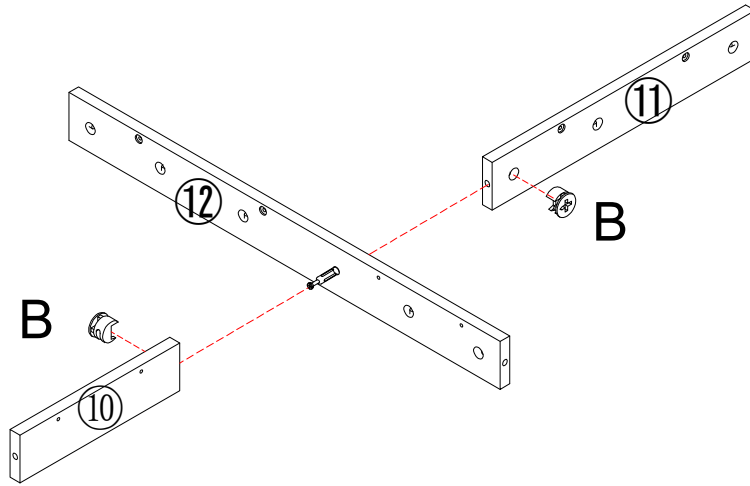

11

B  5PCS

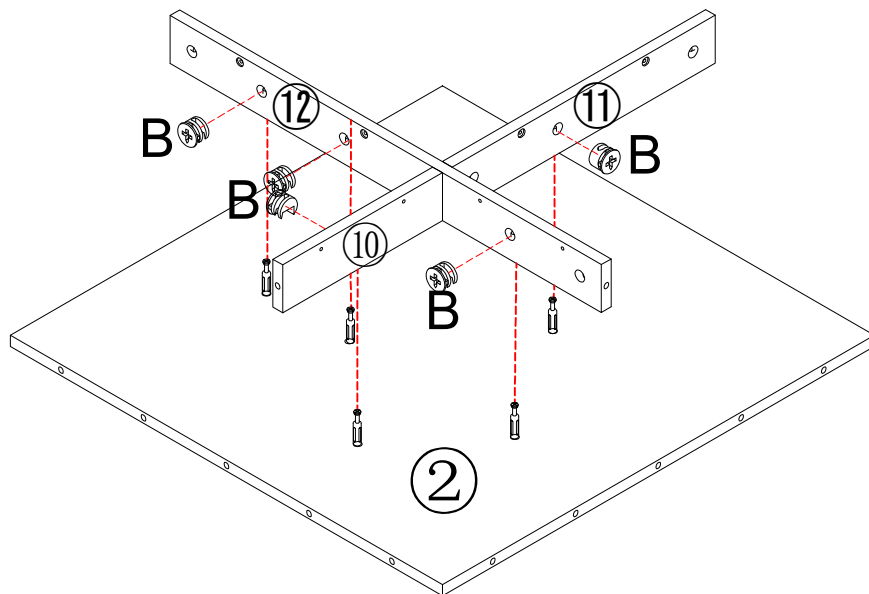

12

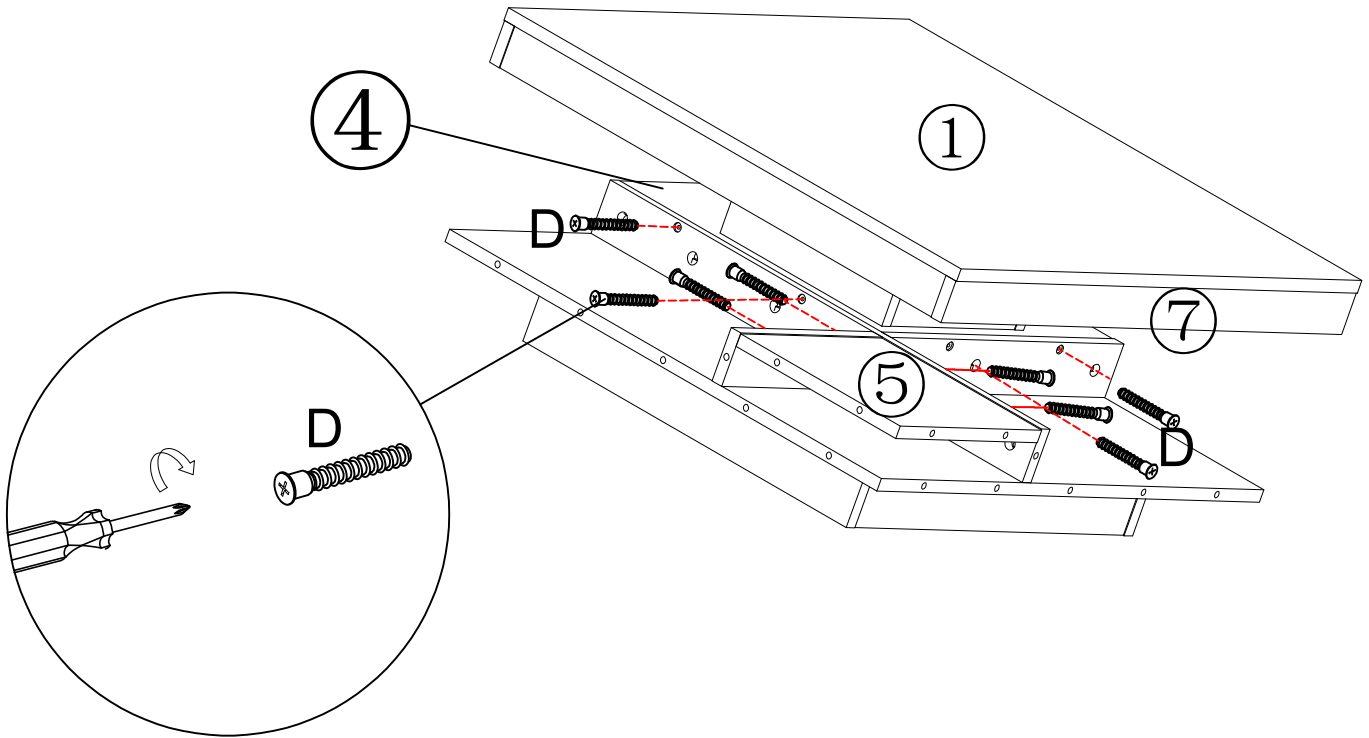
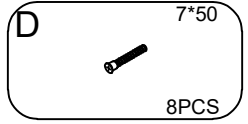

13

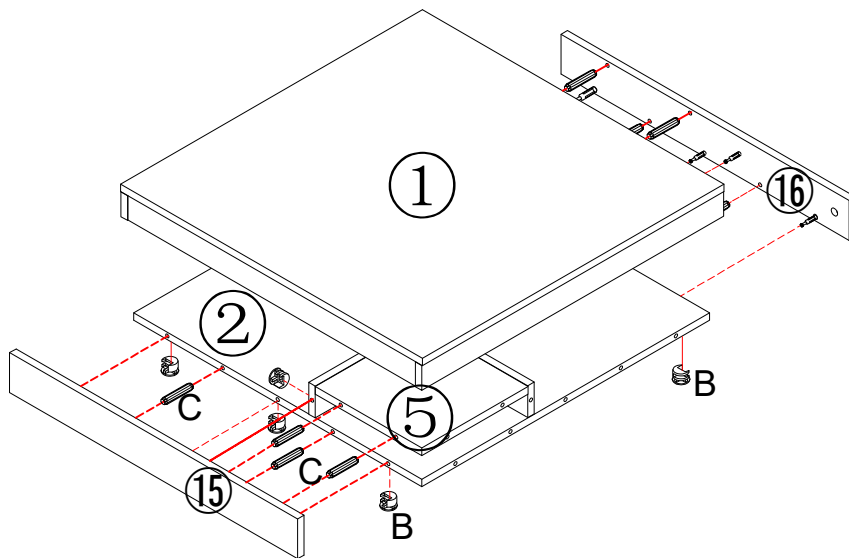
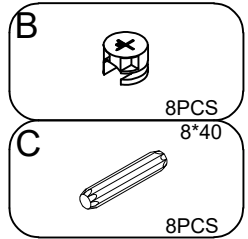

14

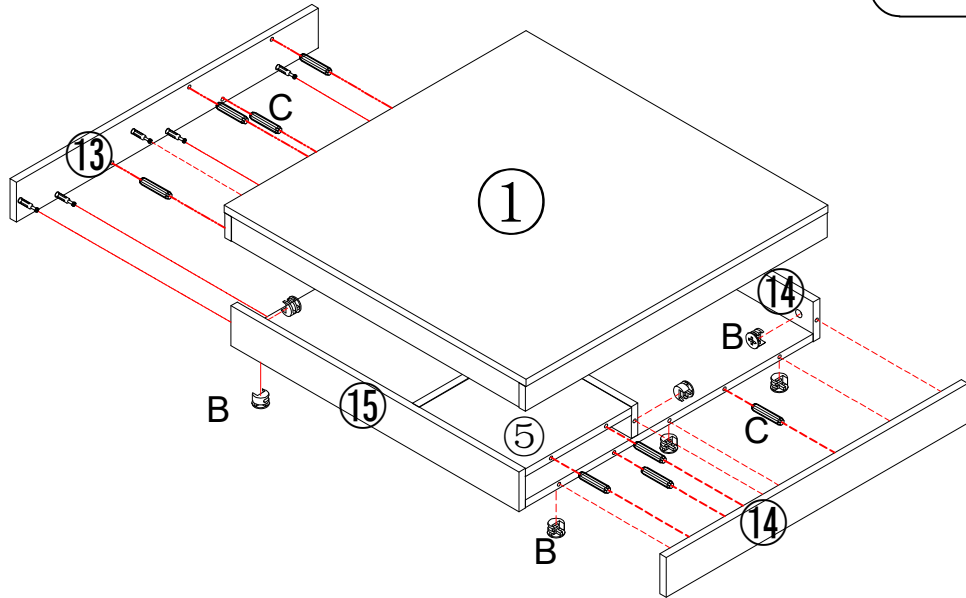
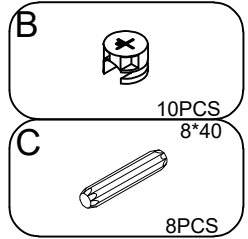

15

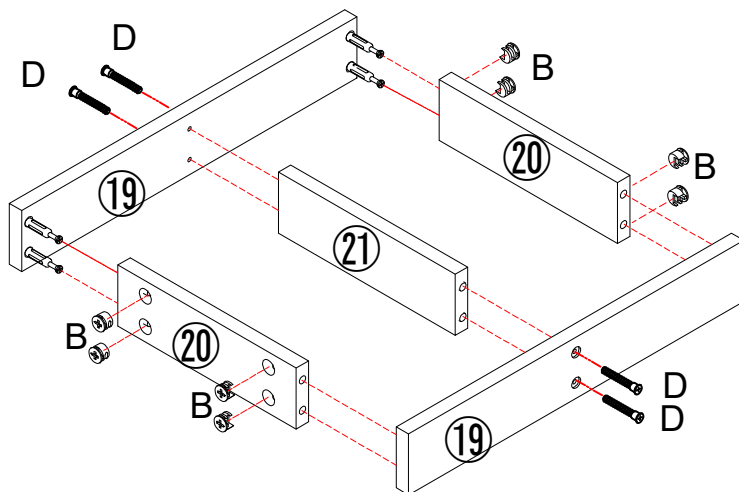
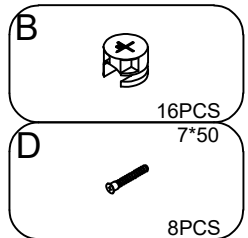

X2

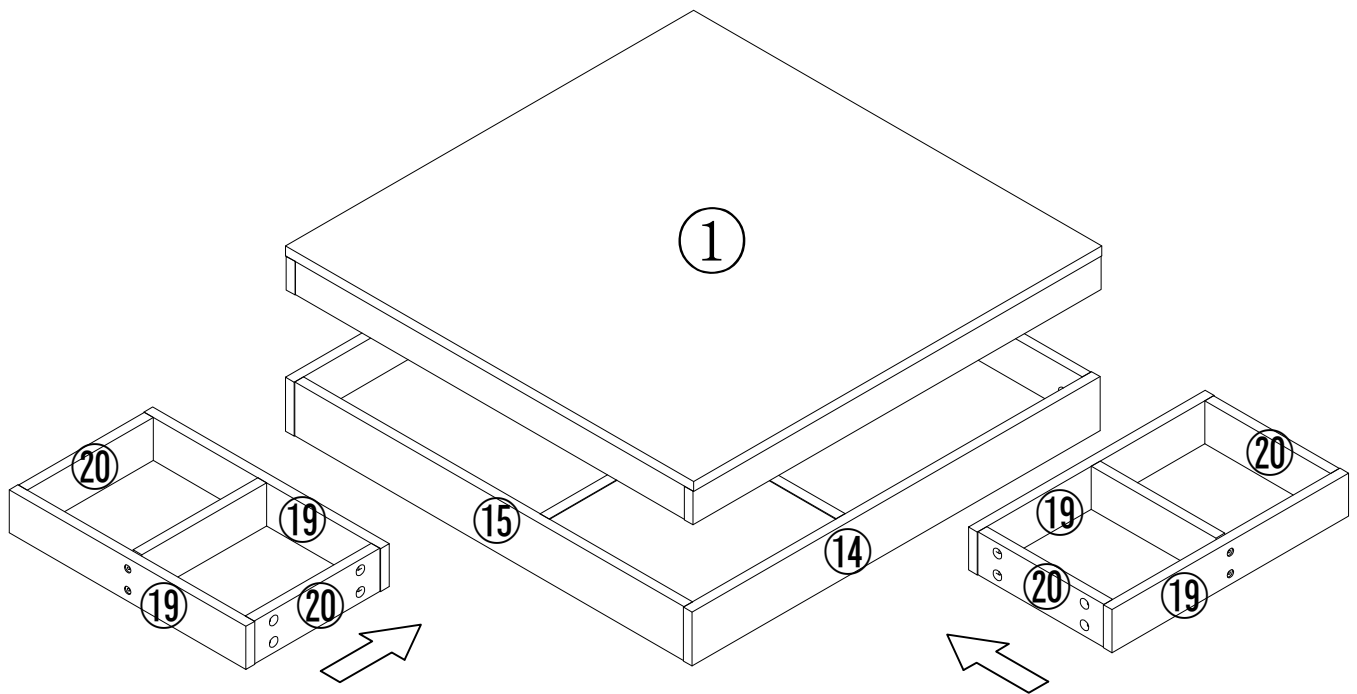



[DE]

BITTE BEACHTEN: Teilenummer 1,6,7,8,9,5,13,14,15 st mit einer dichten Kunststofffolie überzogen. Wenn das Produkt nach der Demontage Kratzer aufweist, machen Sie sich bitte keine Sorgen, es handelt sich nicht um einen Produktschaden.

Bitte ziehen Sie die schützende Kunststofffolie langsam entlang der Kante von der Oberfläche ab. Nach dem Abziehen wird das Produkt glatt und sauber.

[EN]

PLEASE NOTE: Part number 1,6,7,8,9,5,13,14,15 are covered with a tight plastic protective film. If there are scratches on the product after disassembly, please don't worry, it's not product damage. Please slowly tear off the protective plastic film on the surface along the edge. After peeling off, the product becomes smooth and clean.

[FR]

REMARQUE: les pièces numéro 1,6,7,8,9,5,13,14,15 sont recouvertes d'un film protecteur en plastique étanche. Si le produit présente des rayures après le démontage, ne vous inquiétez pas, il ne s'agit pas d'un dommage avéré.

Retirez lentement le film protecteur en plastique sur la surface le long du bord. Une fois décollé, le produit devient lisse et propre.

[IT]

NOTA BENE: il numero di parte 1,6,7,8,9,5,13,14,15 è coperto da una pellicola protettiva in plastica stretta. Se ci sono graffi sul prodotto dopo lo smontaggio, non preoccuparti, non è un danno al prodotto. Strappare lentamente l'epillica protettiva di plastica sulla superficie lungo il bordo. Dopo averla staccata, il prodotto diventa liscio e pulito.

[ES]

NOTA: La pieza número 1,6,7,8,9,5,13,14,15 está cubierta con una película protectora de plástico. Si hay rayones en el producto después de desmontarlo, no se preocupe, no se trata de daños en el producto. Retire lentamente la película protectora de plástico de la superficie a lo largo del borde. Después de despegarla, el producto quedará liso y limpio.